

KA-DV5000 INSTRUCTIONS

# JVC®

**NETWORK PACK STARTUP GUIDE**  
**NETZWERKPACK BEDIENUNGSLEITFADEN**  
**BACK DE RESEAU GUIDE DE DEMARRAGE**  
**GUÍA DE INICIO DEL ADAPTADOR DE RED**  
**GUIDA RAPIDA AL CORREDO DI RETE**

## KA-DV5000

**INSTRUCTIONS**

**BEDIENUNGSANLEITUNG**

**MANUEL D'INSTRUCTIONS**

**ISTRUCCIONES**

**ISTRUZIONI**

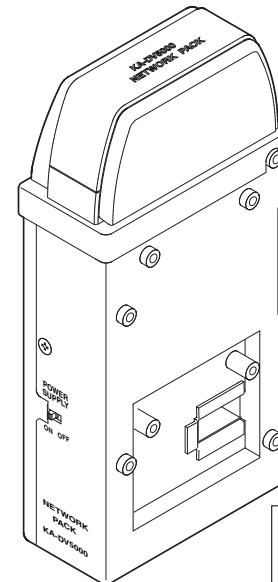

**For Customer Use:**

Enter below the Serial No. which is located on the body. Retain this information for future reference.

Model No. **KA-DV5000**

Serial No. \_\_\_\_\_

This instruction book is made from 100% recycled paper.

**JVC®**  
 VICTOR COMPANY OF JAPAN, LIMITED

JVC® is a registered trademark owned by VICTOR COMPANY OF JAPAN, LTD.  
 JVC® is a registered trademark in Japan, the U.S.A., the U.K. and many other countries.  
 © 2002 VICTOR COMPANY OF JAPAN, LIMITED

 Printed in Japan  
 LST0083-001A

English

Deutsch

Français

Español

Italiano

LST0083-001A

## IMPORTANT SAFEGUARDS

1. Read all of these instructions.
2. Save these instructions for later use.
3. All warnings on the product and in the operating instructions should be adhered to.
4. Unplug this appliance system from the wall outlet before cleaning. Do not use liquid cleaners or aerosol cleaners. Use a damp cloth for cleaning.
5. Do not use attachments not recommended by the appliance manufacturer as they may cause hazards.
6. Do not use this appliance near water – for example, near a bathtub, washbowl, kitchen sink, or laundry tub, in a wet basement, or near a swimming pool, etc.
7. Do not place this appliance on an unstable cart, stand, or table. The appliance may fall, causing serious injury to a child or adult, and serious damage to the appliance. Use only with a cart or stand recommended by the manufacturer, or sold with the appliance. Wall or shelf mounting should follow the manufacturer's instructions, and should use a mounting kit approved by the manufacturer. An appliance and cart combination should be moved with care. Quick stops, excessive force, and uneven surfaces may cause the appliance and cart combination to overturn.
8. Slots and openings in the cabinet and the back or bottom are provided for ventilation, and to insure reliable operation of the appliance and to protect it from overheating, these openings must not be blocked or covered. The openings should never be blocked by placing the appliance on a bed, sofa, rug, or other similar surface. This appliance should never be placed near or over a radiator or heat register. This appliance should not be placed in a built-in installation such as a bookcase unless proper ventilation is provided.
9. This appliance should be operated only from the type of power source indicated on the marking label. If you are not sure of the type of power supplied to your home, consult your dealer or local power company. For appliance designed to operate from battery power, refer to the operating instructions.
10. This appliance system is equipped with a 3-wire grounding type plug (a plug having a third (grounding) pin). This plug will only fit into a grounding-type power outlet. This is a safety feature. If you are unable to insert the plug into the outlet, contact your electrician to replace your obsolete outlet. Do not defeat the safety purpose of the grounding plug.
11. For added protection for this product during a lightning storm, or when it is left unattended and unused for long periods of time, unplug it from the wall outlet and disconnect the antenna or cable system. This will prevent damage to the product due to lightning and power-line surges.
12. Do not allow anything to rest on the power cord. Do not locate this appliance where the cord will be abused by persons walking on it.
13. Follow all warnings and instructions marked on the appliance.
14. Do not overload wall outlets and extension cords as this can result in fire or electric shock.
15. Never push objects of any kind into this appliance through cabinet slots as they may touch dangerous voltage points or short out parts that could result in a fire or electric shock. Never spill liquid of any kind on the appliance.
16. Do not attempt to service this appliance yourself as opening or removing covers may expose you to dangerous voltage or other hazards. Refer all servicing to qualified service personnel.
17. Unplug this appliance from the wall outlet and refer servicing to qualified service personnel under the following conditions:
  - a. When the power cord or plug is damaged or frayed.
  - b. If liquid has been spilled into the appliance.
  - c. If the appliance has been exposed to rain or water.
  - d. If the appliance does not operate normally by following the operating instructions. Adjust only those controls that are covered by the operating instructions as improper adjustment of other controls may result in damage and will often require extensive work by a qualified technician to restore the appliance to normal operation.
  - e. If the appliance has been dropped or the cabinet has been damaged.
  - f. When the appliance exhibits a distinct change in performance – this indicates a need for service.
18. When replacement parts are required, be sure the service technician has used replacement parts specified by the manufacturer that have the same characteristics as the original part. Unauthorized substitutions may result in fire, electric shock, or other hazards.
19. Upon completion of any service or repairs to this appliance, ask the service technician to perform routine safety checks to determine that the appliance is in safe operating condition.

PORTABLE CART WARNING  
(symbol provided by RETACI)



### FOR USA AND CANADA



#### CAUTION

RISK OF ELECTRIC SHOCK  
DO NOT OPEN



CAUTION: TO REDUCE THE RISK OF ELECTRIC SHOCK, DO NOT REMOVE COVER (OR BACK). NO USER-SERVICEABLE PARTS INSIDE. REFER SERVICING TO QUALIFIED SERVICE PERSONNEL.



The lightning flash with arrowhead symbol, within an equilateral triangle is intended to alert the user to the presence of uninsulated "dangerous voltage" within the product's enclosure that may be of sufficient magnitude to constitute a risk of electric shock to persons.



The exclamation point within an equilateral triangle is intended to alert the user to the presence of important operating and maintenance (servicing) instructions in the literature accompanying the appliance.

### INFORMATION FOR USA

#### INFORMATION

This equipment has been tested and found to comply with the limits for a Class B digital device, pursuant to Part 15 of the FCC Rules.

These limits are designed to provide reasonable protection against harmful interference in a residential installation. This equipment generates, uses, and can radiate radio frequency energy and, if not installed and used in accordance with the instructions, may cause harmful interference to radio communications. However, there is no guarantee that interference will not occur in a particular installation. If this equipment does cause harmful interference to radio or television reception, which can be determined by turning the equipment off and on, the user is encouraged to try to correct the interference by one or more of the following measures:

- Reorient or relocate the receiving antenna.
- Increase the separation between the equipment and receiver.
- Connect the equipment into an outlet on a circuit different from that to which the receiver is connected.
- Consult the dealer or an experienced radio/TV technician for help.

#### CAUTION

CHANGES OR MODIFICATIONS NOT APPROVED BY JVC COULD VOID USER'S AUTHORITY TO OPERATE THE EQUIPMENT.

THIS DEVICE COMPLIES WITH PART 15 OF THE FCC RULES. OPERATION IS SUBJECT TO THE FOLLOWING TWO CONDITIONS: (1) THIS DEVICE MAY NOT CAUSE HARMFUL INTERFERENCE, AND (2) THIS DEVICE MUST ACCEPT ANY INTERFERENCE RECEIVED, INCLUDING INTERFERENCE THAT MAY CAUSE UNDESIRE OPERATION

### Information for USA

This device complies with part 15 of the FCC Rules. Changes or modifications not approved by JVC could void the user's authority to operate the equipment.

### INFORMATION (FOR CANADA)

This Class B digital apparatus complies with Canadian ICES-003.

### RENSEIGNEMENT (POUR CANADA)

Cet appareil numérique de la Class B est conforme à la norme NMB-003 du Canada.

## Safety Precautions

Thank you for purchasing this product.  
(These instructions are for KA-DV5000U)  
Before beginning to operate this unit, please read the instruction manual carefully in order to make sure that the best possible performance is obtained.

Due to design modifications, data given in this instruction book are subject to possible change without prior notice.

**WARNING:**  
TO REDUCE THE RISK OF FIRE OR ELECTRIC SHOCK, DO NOT EXPOSE THIS APPLIANCE TO RAIN OR MOISTURE.

**AVERTISSEMENT:**  
POUR EVITER LES RISQUES D'INCENDIE OU D'ELECTRO-CUTION, NE PAS EXPOSER L'APPAREIL A L'HUMIDITE OU A LA PLUIE.

### POWER SYSTEM

#### Connection of POWER supply

The power for the network pack is supplied through the camera that is connected to the network pack.

This equipment is in conformity with the provisions and protection requirements of the corresponding European Directives. This equipment is designed for professional video appliances and can be used in the following environments:

- residential area (in houses) or rural area
- commercial and light industry; e.g. offices or theatres
- urban outdoors

In order to keep the best performance and furthermore for electromagnetic compatibility. Use the PC Card which acquired a CE mark.

### Caution

Where there are strong electromagnetic waves or magnetism, for example near a radio or TV transmitter, transformer, motor, etc., the picture may be disturbed. In such case, please keep the apparatus away from the sources of the disturbance.

## Product Components

### Network Pack KA-DV5000

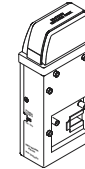

Adapter for encoding/decoding video/audio data by connecting to GY-DV5000.

### Network Pack Startup Guide (This document)

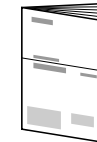

This document describes the basic matters for use of the Network Pack.

### CD-ROM

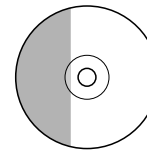

The following software and these Instructions are included on the provided CD-ROM.

#### • Streamproducer Software

Software used for distributing movies on a network.

#### • Network Pack User's Guide (pdf)

Reference guide for the Network Pack.

#### • User's Guide (pdf) to "Streamproducer" – the software for network distribution.

Software for live broadcasting and distribution on networks.

Setting of the KA-DV5000 is performed on the menu screen of the GY-DV5000 camcorder. For details on the setting methods, please see the Network Pack User's Guide (pdf) included on the provided CD-ROM.

#### CD-ROM MENU Network Pack User's Guide (pdf)

When the Streamproducer program included on the provided CD-ROM is installed, the Network Pack User's Guide (pdf) is automatically installed on the PC and added to the Start menu.

#### [Start/Programs/KA-DV5000U/User's Guide]

The Adobe Acrobat Reader is required to view PDF files.

## Contents

Features .....	4
Precautions .....	4
What the KA-DV5000 can be used for .....	6
Controls, Connectors and Indicators .....	8
How to Attach .....	9
Confirming correct attachment .....	10
Installing Streamproducer .....	11
Specifications .....	12

## Features

- By connecting the unit to GY-DV5000, video/audio of camera or tape playback can be encoded/decoded in realtime. Video data is converted to MPEG-4 and audio data is converted to G726.
- Installing a LAN-card in the PC card slot enables real-time streaming.
- Installing a Compact Flash card in the PC card slot enables real-time capturing.
- Network distribution of the video/audio file created by the KA-DV5000 is possible when the "Streamproducer" program included on the provided CD-ROM is installed on the PC.

## Precautions

- Be sure to turn the camcorder's power supply OFF before the KA-DV5000 is attached to the camcorder.
  - Be sure to turn the camcorder's power supply OFF before inserting or removing CF (Compact Flash) cards, etc., into and from the camcorder. Inserting or removing cards while the camcorder's power supply is turned ON can result in corruption of the recorded sections of the card or damage to the card itself.
  - The KA-DV5000 accepts the following cards for which operation has been confirmed: (As of August 2002)
 

Operating voltage	5 V or 3.3 V
Current consumption	500 mA (5 V)

    - Wired LAN-card
 

US:	EA2900-117 (Revision C) (Name of manufacturer: Socket Communications, Inc) <sup>*1</sup>
Europe:	EA2903-162 (Revision C) (Name of manufacturer: Socket Communications, Inc) <sup>*1</sup>
Asia:	EA2906-194 (Revision C) (Name of manufacturer: Socket Communications, Inc) <sup>*1</sup>

 (The Revision designation is indicated in the upper right of the serial number label affixed to the package.)
    - Wireless LAN-card
 

TEW-201PC, TEW-202CF (Name of manufacturer: TRENDware)
WCF11 (Name of manufacturer: LINKSYS) <sup>*2</sup>
    - CF (Compact Flash) card
 

SDCFB-16 ~ SDCFB-256 (Name of manufacturer: SanDisk) <sup>*1</sup>
--

 \*1: Use PCMCIA card TYPE I or TYPE II adapter  
 \*2: Use PCMCIA card TYPE II adapter
- Do not use other cards that those for which operation has been confirmed. Improper installation may cause damage to the KA-DV5000.  
 For the latest operational check card, visit the website below or contact your JVC dealer.  
<http://www.jvc-victor.co.jp/english/pro/prodv/stream/>

\* The names of actual companies and products mentioned in this document may be the trademarks or registered trademarks of their respective owners.  
 In this document, symbols like ™, ®, ©, etc. have been omitted.

## Precautions (cont'd)

### Streamproducer Operating Environment

- Under the following conditions, the Streamproducer can be used in the required operating environment.
  - When using 1 camera or 1 file.
  - When recording of the camera image is not performed.
  - When switched distribution is not performed.

#### Required operating environment

Hardware	
CPU	Pentium III 700 MHz
Memory	128 MB
Display	XGA (1024 X 768)
Hard disk	* 50 MB for installation * 1 hour viewing time requires empty hard disk space equivalent to 25 MB (high compression) to 200 MB (low compression).
Network	* 1 LAN system for connecting the network pack * Internet connection to download codec program for playback of moving pictures * Other network environment for distribution if distribution is to be performed in other environment than that described above
Software	
OS	Windows 2000 Professional (English), Windows XP Home Edition, Windows XP Professional
Others	An environment in which Windows Media Player 7.1 or later is already installed is necessary for installation of Streamproducer

- When using multiple cameras or files, the following operating environment is recommended in order to make full use of the application's functions.

#### Recommended Operation Environment

Hardware	
CPU	Pentium 4 2.2 GHz or higher
Memory	512 MB or more
Display	SXGA (1280 X 1024) or more

Other operating environment demands are the same as the required operating environment demands.

#### MEMO

The described required operating environment and recommend operating environment are both meant as guidelines to ensure optimal use of the application but are not meant as guarantee of operation. Also, even if you use a computer that complies with the operating environment, optimal use of the application may not be obtainable due to the configuration of your system.

## What the KA-DV5000 can be used for

### Sending camera video/audio by email using CF (Compact Flash) card

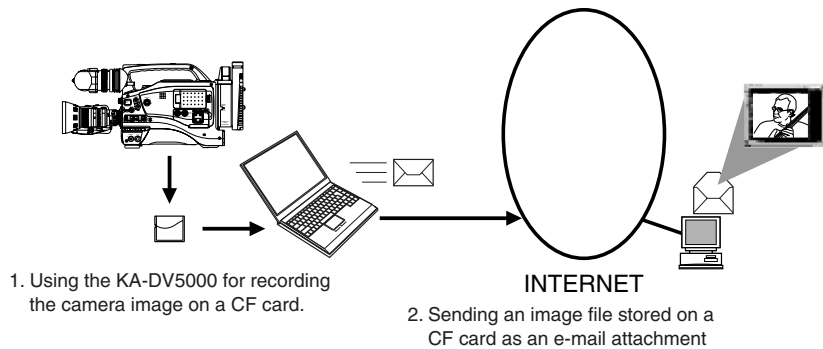

#### Operation method

☞ See Network Pack User's Guide (pdf) "CF card recording"

### Viewing and filing camera images on your PC using "Streamcapture"

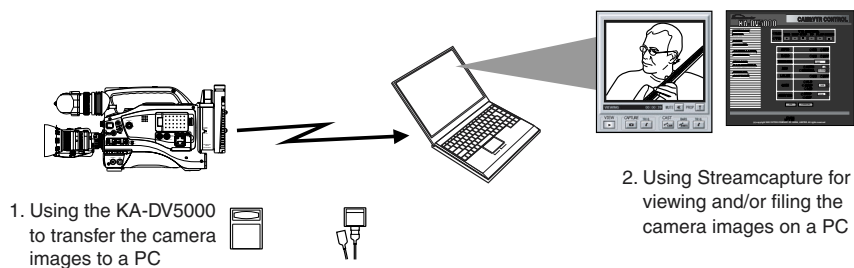

#### Operation method

☞ • See "LAN card", "Streamcapture" in the Network Pack User's Guide (pdf)  
 • See the User's Guide to the "Streamproducer" software for network distribution.

#### Operating environment

- Windows 2000, Windows XP Home Edition, Windows XP Professional
- Internet Explorer 5.01, 5.5 or 6.0
- JavaScript enabled

## What the KA-DV5000 can be used for (cont'd)

### Connecting a notebook computer for remote control with monitor

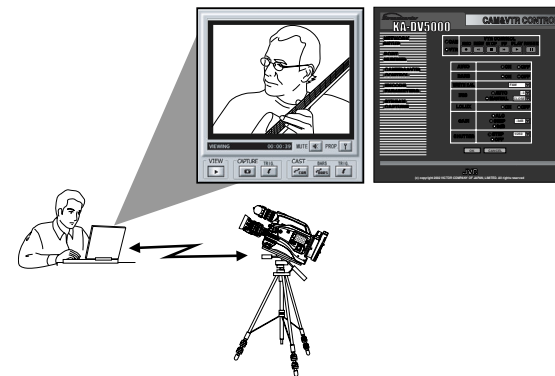

Camera settings and VTR control can be performed using a notebook computer.

#### Operation method

☞ See "Streamcodec" in the Network Pack User's Guide.

### Distributing camera images on an intranet

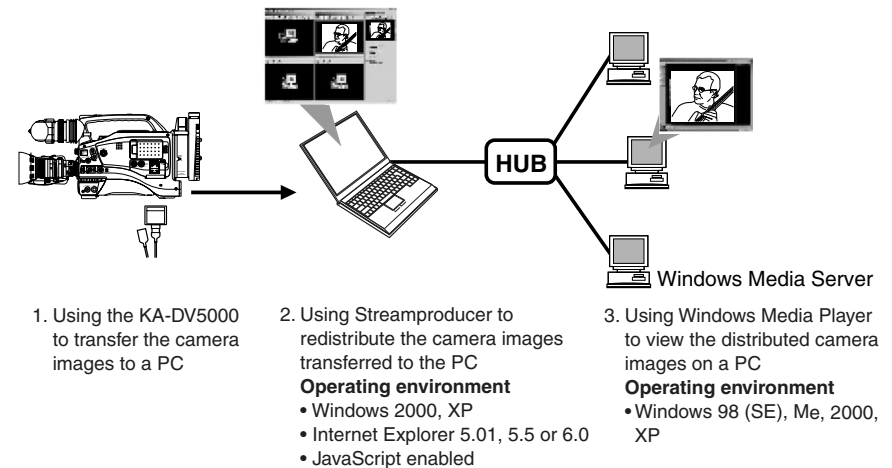

#### Operation method

☞ • See the User's Guide to the "Streamproducer" software for network distribution.  
 • See "Network settings", "LAN card" in the Network Pack User's Guide (pdf)

## Controls, Connectors and Indicators

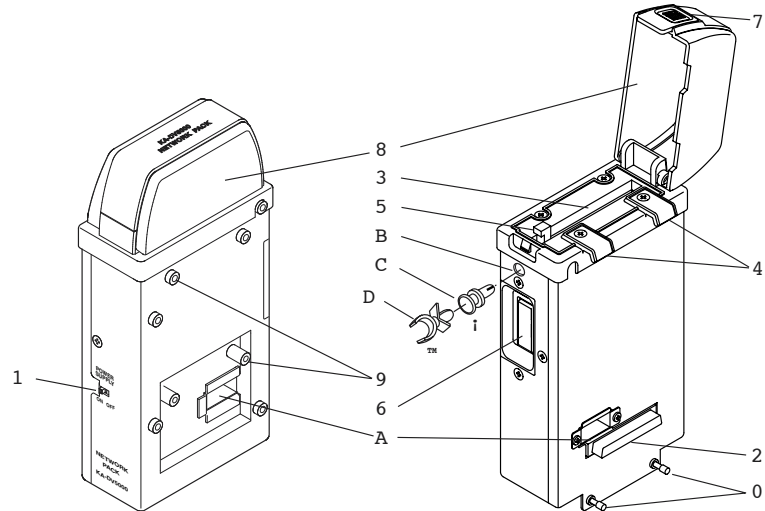

### 1 Power switch

### 2 Camera connection terminal

For connecting DV camcorder (GY-DV5000). (See page 9)

### 3 PC card slot

For inserting LAN card, Compact Flash card, etc.

### 4 Main unit mounting hooks

Used when mounting to the main unit by hooking to the cut-away section of the camcorder.

### 5 EJECT button

Press when ejecting card.

### 6 Service terminal

Do not use.

### 7 Lock/release button

To open the cover, press the [PUSH] section and lift.

### 8 Cover

Cover for the PC card slot. The cover can be removed by opening and twisting in a backward direction.

### 9 Battery case mounting screws

Screws for mounting the battery case after attaching the main unit.

### 0 Main unit mounting screws

Used when mounting the main unit to the camera.

### A Battery case wire passage

### B Cable clamp mounting hole

Hole for attaching the included cable clamp. Remove the bushing before attaching the cable clamp.

### C Bushing

### D Cable clamp (included)

### For use with LAN card cable and LAN cable.

#### i Remove the bushing.

Remove by pinching the head of the bushing.

#### ™ Attach the cable clamp

E-8

## How to Attach

Below is the procedure for attaching the main unit to the DV camcorder.

Mount using the procedure shown below.

1 Turn off the camcorder power.

2 Remove the battery case.

Remove the battery case mounting screws on the back of GY-DV5000, remove the battery case and remove the internal connector.

See page 35 of the GY-DV5000 Instruction Manual

3 Insert the connector wire of the camcorder through the back of the network pack to the front.

4 Tilt the network pack diagonally, set the upper hooks on the cut-away section of the camcorder from the top and turn downward.

### Caution

Make sure the cushion does not shift when hooking the network pack to the cut-away section of the camera.

5 Align the connectors of the network pack and camcorder and connect.

6 Mount the network pack to the camcorder using the 2 mounting screws on the lower section of the network pack.

7 Mount the battery case on the back of the network pack.

Insert the cushion on the back of the network pack, connect the connector from the network pack to the connector on the battery case, clamp wires as shown below, and fix the battery case to the back of the network pack using the mounting screws.

See page 35 of the GY-DV5000 Instruction Manual

### Storing the connector

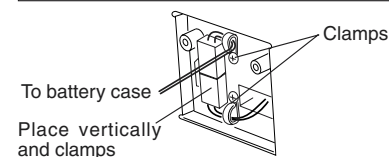

To battery case

Place vertically and clamps

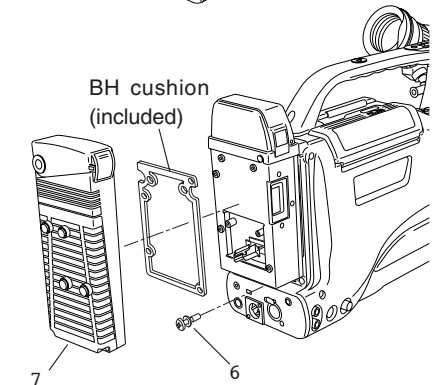
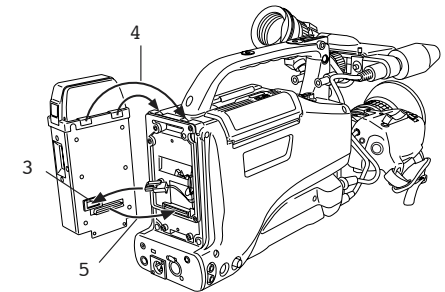
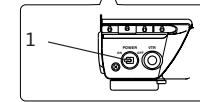
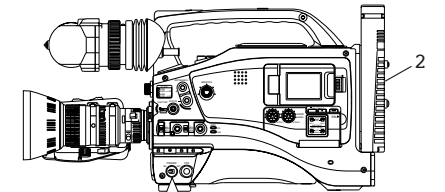

BH cushion (included)

### Caution

Fix unused connector wire to the back of the camera or back of network pack using the clamps so that the wire does not become pinched.

E-9



## Confirming correct attachment

Check to see whether the main unit has been mounted correctly using the procedure shown below.

- 1 Turn off the power of GY-DV5000 and KA-DV5000.
- 2 Press the button on the side of the main unit, open the cover and insert a card in the card slot.
- 3 Close the cover and turn on the KA-DV5000 power.
- 4 Turn on the GY-DV5000 power.
- 5 Check the card status. Check to see that the card status according to the card type is displayed on the LCD monitor and viewfinder screen of GY-DV5000.

### Memo

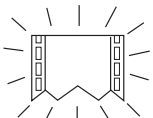

During initialization after the power is turned on, the card status display shown on the left is displayed.

### Caution

Be sure to turn off the GY-DV5000 power before removing card.

## Removing/attaching the cover

### Removing the cover

- 1 Open the cover.
- 2 Remove by pressing in as shown on the right so that the cover widens on sides.

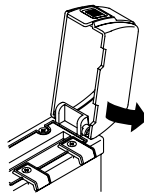

### Attaching the cover

Perform the steps above in reverse.

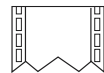
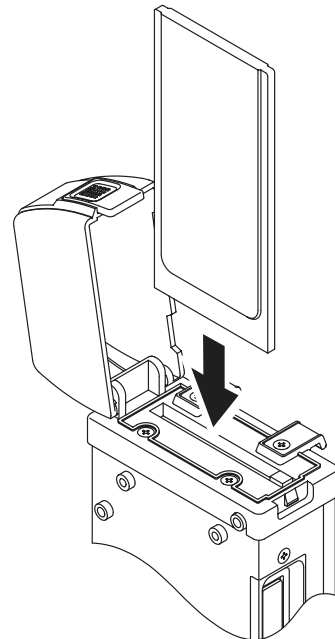

: Card not inserted



: LAN card



: Compact Flash card

### Memo

Depending on the card shape, the cover may get in the way or may not close correctly. In this case, the cover can be removed by twisting the cover backward while it is open.

## Installing Streamproducer

1. Insert the CD-ROM with Streamproducer into the CD-ROM drive.



Wait until the access lamp of the CD-ROM drive goes out.

The screen shown on the left appears.

2. Click on "English".



The screen shown on the left appears.

3. Click on "Install Streamproducer".

The Installer starts up.

Detailed information on how to operate the Streamproducer is described in the "Read User's Guide", so please refer to this.

The "Read User's Guide" can be invoked by selecting: Start menu/Programs/Streamproducer/User's Guide.

## Specifications

- Mass: 480 g (main unit only)
- Power supply: Supplied from the GY-DV5000
- Power consumption: DC 12 V  $\approx$  0.5 A (main unit only)
- Allowable operating temperature: 0°C to 40°C
- Allowable storage temperature: -20°C to 60°C
- Allowable operating humidity: 30% to 80% RH
- Provided accessories  
CD-ROM  
INSTRUCTIONS  
Warranty Card (USA and Canada only)  
BH Cushion  
Cable Clamp

- External Dimensions (Unit: mm)

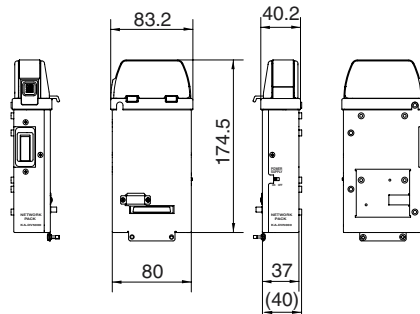

Design and specifications are subject to change without notice.



KA-DV5000 NETWORK PACK

**JVC**<sup>®</sup>

NETWORK PACK

**KA-DV5000**

User's Guide

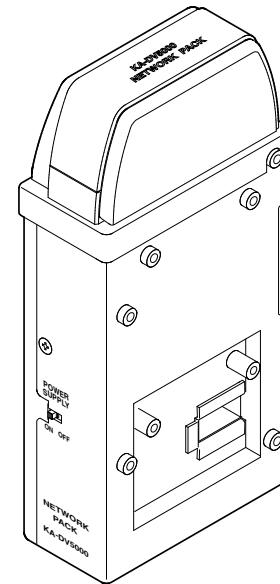

**JVC**<sup>®</sup>  
VICTOR COMPANY OF JAPAN, LIMITED

**JVC**<sup>®</sup> is a registered trademark owned by VICTOR COMPANY OF JAPAN, LTD.  
**JVC**<sup>®</sup> is a registered trademark in Japan, the U.S.A., the U.K. and many other countries.  
© 2002 VICTOR COMPANY OF JAPAN, LIMITED

When attaching Network Pack KA-DV5000 to DV Camcorder GY-DV5000, network related menus are added to the GY-DV5000 menu screen.

This User's Guide explains settings for the network related menus, operation for recording streaming data to a CF (Compact Flash) memory card and operation for sending streaming data using a LAN card. When a LAN card is connected, menu screen settings for the Network Pack and GY-DV5000 can be operated from your PC.

## Contents

### Introduction

Inserting/removing CF memory card/LAN card .....	3
LCD screen/viewfinder screen .....	4

### Menu screen

Menu screen structure .....	5
NETWORK PACK CONFIG menu screen items .....	6
Setting the NETWORK PACK CONFIG menu screen .....	8
Returning the NETWORK PACK CONFIG menu screen to factory settings .....	9

### Network settings

Setting the NETWORK SET menu screen .....	10
NETWORK SET menu screen items .....	11
USER PAGE can be customized .....	12
Making network related settings .....	13
Detailed IP settings (LAN) .....	14
Detailed network settings (WLAN) .....	15

### Recording on a CF card

Formatting a CF memory card .....	17
CF memory recording time .....	17
Recording video on a DV cassette tape and CF memory card .....	18
Recording video on a CF memory card only .....	19
Recording playback signals of a DV cassette tape on a CF memory card .....	20
Deleting all clip files on a CF memory card .....	21

### Movie clips

Playing back video/audio recorded on a CF memory card .....	22
Protecting a clip file on a CF memory card .....	24
Deleting a clip file on a CF memory card .....	25
Playing back CF memory card clips on your PC .....	26

### LAN card

Sending video using LAN card while recording on a DV cassette tape .....	27
Sending video using a LAN card (no DV cassette tape recording) .....	28
Sending playback signals of a DV cassette tape using a LAN card .....	29

### Network Pack Setup

Controlling GY-DV5000/KA-DV5000 via LAN a card .....	30
CAM & VTR CONTROL screen .....	31
NETWORK SETUP screen .....	33
PORT SETUP screen .....	34
ENCODE PARAMETERS screen .....	35
Streamcapture screen (Playing back video/audio using a PC and saving to file) .....	36

### Others

Troubleshooting .....	40
Checking communication/connection .....	42
Terminology .....	43

Characters and symbols used in this instruction book	
Caution	Cautionary notes concerning operation of the unit
Memo	Reference such as restrictions of features, etc.
☞	Reference page or item

\* In general, the names of products manufactured by other companies and mentioned in these instructions are trademarks or registered trademarks of these companies. Symbols like ™, ©, ®, etc., are not used in these instructions.

## Introduction

## Inserting/removing CF memory card/LAN card

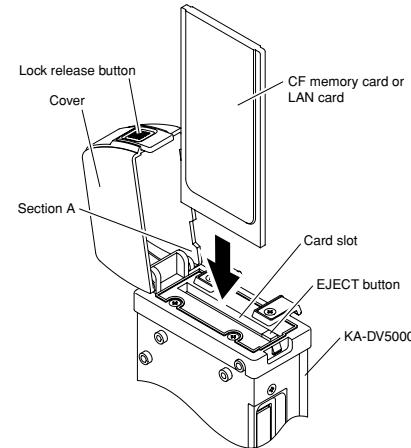

- The KA-DV5000 accepts the following cards for which operation has been confirmed: (As of August 2002)
  - Operating voltage: 5 V or 3.3 V
  - Current consumption: Max. 500 mA (5 V)
- Wired LAN-card
  - US: EA2900-117 (Revision C) (Name of manufacturer: Socket Communications, Inc)<sup>1</sup>
  - Europe: EA2903-162 (Revision C) (Name of manufacturer: Socket Communications, Inc)<sup>1</sup>
  - Asia: EA2906-194 (Revision C) (Name of manufacturer: Socket Communications, Inc)<sup>1</sup>
- \* Revision indicated on the upper right of package production label.
- Wireless LAN-card
  - TEW-PC16 (firmware version 0.8.3 or later) (Name of manufacturer: TRENDware)
  - WCF11 (Name of manufacturer: LINKSYS)<sup>2</sup>
  - TEW-201PC
  - TEW-202CF
  - Wireless Networker Compact Flash
    - (Name of manufacturer: SYMBOL TECHNOLOGIES INC.)
    - FCCID: H9PLA4B7P
  - TEW-PC202CF
    - (Name of manufacturer: TREND net)
    - FCCID: MXF-F90120
  - Low Power WLAN CARD
    - (Name of manufacturer: Socket Communications, Inc)
    - FCCID: H9PLA4137P
  - AIR-PCM350
    - (Name of manufacturer: Cisco Systems)
    - FCCID: LDK102040
- CF (Compact Flash) card
  - SDCFB-16 ~ SDCFB-256 (Name of manufacturer: SanDisk)<sup>1</sup>
- <sup>1</sup>: Use PCMCIA card TYPE I or TYPE II adapter
- <sup>2</sup>: Use PCMCIA card TYPE II adapter

### Caution

- Make sure the power of GY-DV5000 is off when inserting/removing a CF memory card/LAN card. Inserting/removing a card with the unit power on may damage the data storage section of the CF memory card or the card itself.
- Do not use the wireless LAN card continuously for more than 48 hours.

For the latest operational check card, visit the website below or contact your JVC dealer.  
<http://www.jvc-victor.co.jp/english/pro/prodv/stream/>

### Inserting card

- Turn off the GY-DV5000 power.
- Press and hold the lock release button and open the cover.
- Insert a card into the KA-DV5000 card slot. Then, close the cover.
  - The cover may not close depending on the wired LAN card or the card shape. In this case, remove the cover by pressing section A and pulling on the cover.
- Turn on the GY-DV5000 power.
- Turn on the KA-DV5000 power.

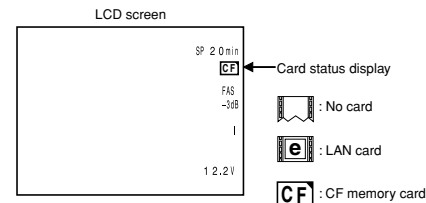

- Card status according to the inserted card type is displayed on the LCD screen/viewfinder screen. (☞ page 4)  
 (The viewfinder will show the status in black and white.)

### Memo



When turning the power on, the card status display shown on left will flash during initialization.

### Removing card

- Turn off the GY-DV5000 power, or turn off the KA-DV5000 power.
- Open the cover, press the EJECT button of KA-DV5000 and remove the card.

# Introduction

## LCD screen/viewfinder screen

Information from Network Pack KA-DV5000 is displayed on the GY-DV5000 LCD screen/viewfinder screen.

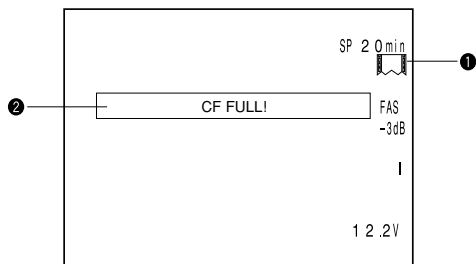

### 1 Card status displays

Display	Description
	No card is inserted in Network Pack. Flashing display during initialization (after power on).
	LAN card is inserted in Network Pack.
	Video/audio data is being sent from LAN card.
	CF memory card is inserted in Network Pack.
	CF memory card is being recorded with data.
	Card is inserted in Network Pack but transmission is not available. There is possibility of unit malfunction. Contact your nearest JVC dealer.

No colors will be shown on the viewfinder.

### 2 CF Memory card warning display

Displays CF memory card status and system errors.

\* For details concerning warning displays, see page 40.

# Menu screen

## Menu screen structure

When attaching Network Pack KA-DV5000 to DV Camcorder GY-DV5000, NETWORK PACK CONFIG menu and MOVIE CLIP menu are added to the GY-DV5000 TOP MENU screen.

### MODE switch: When CAM-A or CAM-B is selected

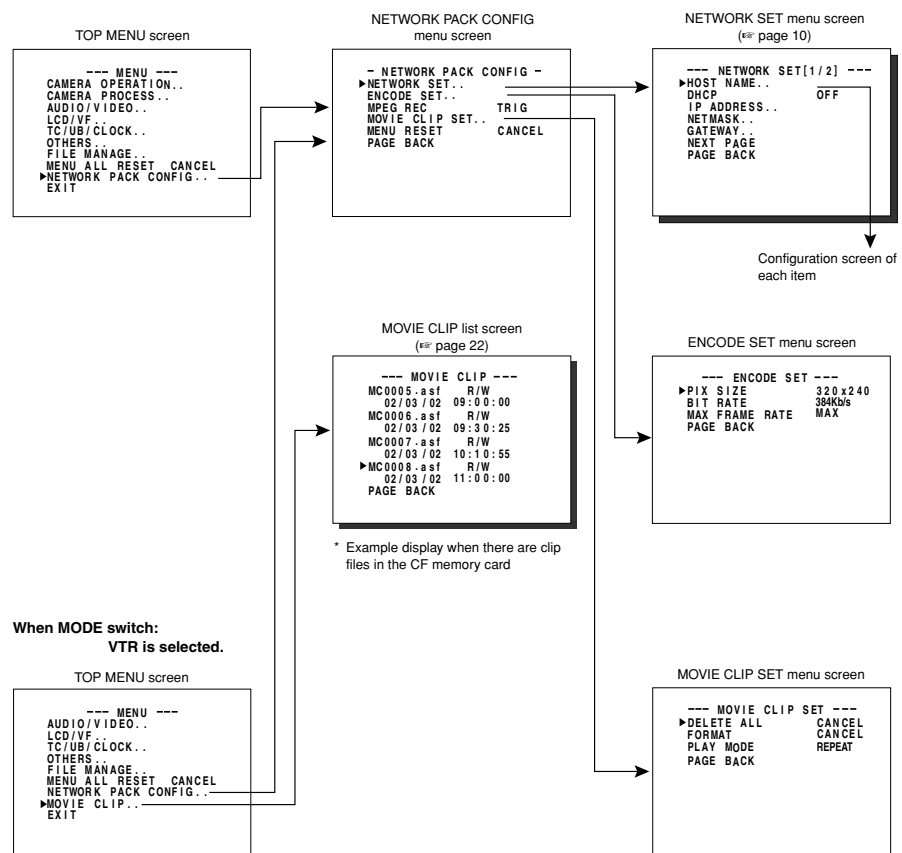

### When MODE switch: VTR is selected.

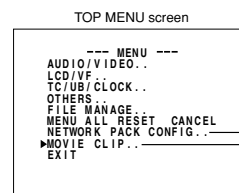

## Menu screen

### NETWORK PACK CONFIG menu screen items

● indicates default factory setting.

Item	Setting	Description																																																																																																																	
NETWORK SET		Displays menu screen for network related settings such as DHCP, IP address, subnet mask, etc. (☞ page 11)																																																																																																																	
ENCODE SET		Displays menu screen for setting video and audio compressions.																																																																																																																	
PIX SIZE	●320 × 240 160 × 120	Sets the video compression size. 320 × 240: Sets the image size to 320 × 240 pixels. (SIF) 160 × 120: Sets the image size to 160 × 120 pixels. (QSIF) (1/4 image size of SIF.)																																																																																																																	
VIDEO RATE	56K 128K 256K ●384K 512K	Sets streaming speed (bps). 56K: MPEG4 24 kbps G726 16 kbps 128K: MPEG4 104 kbps G726 16 kbps 256K: MPEG4 232 kbps G726 24 kbps 384K: MPEG4 352 kbps G726 32 kbps 512K: MPEG4 472 kbps G726 40 kbps																																																																																																																	
MAX FRAME RATE ( ) : for E model	MAX ●MID MIN	Sets the frame rate per second. Settings are as shown below.																																																																																																																	
		<table border="1"> <thead> <tr> <th rowspan="3">BIT RATE (bps)</th> <th colspan="6">PIX SIZE</th> </tr> <tr> <th colspan="3">320 × 240</th> <th colspan="3">160 × 120</th> </tr> <tr> <th>MAX</th> <th>MID</th> <th>MIN</th> <th>MAX</th> <th>MID</th> <th>MIN</th> </tr> </thead> <tbody> <tr> <td rowspan="2">512K</td> <td>NTSC</td> <td>15</td> <td>10</td> <td>7.5</td> <td>30</td> <td>15</td> <td>10</td> </tr> <tr> <td>PAL</td> <td>12.5</td> <td>5</td> <td>5</td> <td>25</td> <td>12.5</td> <td>12.5</td> </tr> <tr> <td rowspan="2">384K</td> <td>NTSC</td> <td>15</td> <td>10</td> <td>7.5</td> <td>30</td> <td>15</td> <td>10</td> </tr> <tr> <td>PAL</td> <td>12.5</td> <td>5</td> <td>5</td> <td>25</td> <td>12.5</td> <td>5</td> </tr> <tr> <td rowspan="2">256K</td> <td>NTSC</td> <td>15</td> <td>7.5</td> <td>5</td> <td>30</td> <td>15</td> <td>7.5</td> </tr> <tr> <td>PAL</td> <td>12.5</td> <td>5</td> <td>5</td> <td>25</td> <td>12.5</td> <td>5</td> </tr> </tbody> </table> <table border="1"> <thead> <tr> <th rowspan="3">BIT RATE (bps)</th> <th colspan="6">PIX SIZE</th> </tr> <tr> <th colspan="3">320 × 240</th> <th colspan="3">160 × 120</th> </tr> <tr> <th>MAX</th> <th>MID</th> <th>MIN</th> <th>MAX</th> <th>MID</th> <th>MIN</th> </tr> </thead> <tbody> <tr> <td rowspan="2">128K</td> <td>NTSC</td> <td>7.5</td> <td>5</td> <td>3</td> <td>15</td> <td>10</td> <td>7.5</td> </tr> <tr> <td>PAL</td> <td>5</td> <td>5</td> <td>1</td> <td>12.5</td> <td>12.5</td> <td>5</td> </tr> <tr> <td rowspan="2">56K</td> <td>NTSC</td> <td>3</td> <td>1</td> <td>1</td> <td>10</td> <td>7.5</td> <td>5</td> </tr> <tr> <td>PAL</td> <td>1</td> <td>1</td> <td>1</td> <td>12.5</td> <td>5</td> <td>5</td> </tr> </tbody> </table> <p>* The frame rates shown in the table are not guaranteed values.</p>	BIT RATE (bps)	PIX SIZE						320 × 240			160 × 120			MAX	MID	MIN	MAX	MID	MIN	512K	NTSC	15	10	7.5	30	15	10	PAL	12.5	5	5	25	12.5	12.5	384K	NTSC	15	10	7.5	30	15	10	PAL	12.5	5	5	25	12.5	5	256K	NTSC	15	7.5	5	30	15	7.5	PAL	12.5	5	5	25	12.5	5	BIT RATE (bps)	PIX SIZE						320 × 240			160 × 120			MAX	MID	MIN	MAX	MID	MIN	128K	NTSC	7.5	5	3	15	10	7.5	PAL	5	5	1	12.5	12.5	5	56K	NTSC	3	1	1	10	7.5	5	PAL	1	1	1	12.5	5	5
BIT RATE (bps)	PIX SIZE																																																																																																																		
	320 × 240			160 × 120																																																																																																															
	MAX	MID	MIN	MAX	MID	MIN																																																																																																													
512K	NTSC	15	10	7.5	30	15	10																																																																																																												
	PAL	12.5	5	5	25	12.5	12.5																																																																																																												
384K	NTSC	15	10	7.5	30	15	10																																																																																																												
	PAL	12.5	5	5	25	12.5	5																																																																																																												
256K	NTSC	15	7.5	5	30	15	7.5																																																																																																												
	PAL	12.5	5	5	25	12.5	5																																																																																																												
BIT RATE (bps)	PIX SIZE																																																																																																																		
	320 × 240			160 × 120																																																																																																															
	MAX	MID	MIN	MAX	MID	MIN																																																																																																													
128K	NTSC	7.5	5	3	15	10	7.5																																																																																																												
	PAL	5	5	1	12.5	12.5	5																																																																																																												
56K	NTSC	3	1	1	10	7.5	5																																																																																																												
	PAL	1	1	1	12.5	5	5																																																																																																												
PAGE BACK		Pressing the SHUTTER dial returns to the NETWORK PACK CONFIG menu screen.																																																																																																																	
MPEG REC	●TRIG SPLIT OFF	<p>Selects the operation method for recording video data to a CF memory card or sending data to a remote media from a LAN card.</p> <p>TRIG: Pressing the VTR trigger button of GY-DV5000 starts operation. Use this setting when simultaneously recording to a DV tape.</p> <p>SPLIT: Use this setting when recording or transferring with CF memory card or LAN card only. Operation starts when pressing the VTR trigger button on the side of GY-DV5000.</p> <div style="border: 1px solid black; padding: 5px; margin: 10px 0;"> <p><b>Memo</b></p> <p>When SPLIT is selected, the unit will not operate even when pressing the VTR trigger button on the front or on the lens.</p> </div> <p>OFF: Recording will not be made to the CF memory card and streaming data from the LAN card will not be recorded/sent to the PC even when pressing the VTR trigger button of GY-DV5000.</p>																																																																																																																	

→ OVER

## Menu screen

### NETWORK PACK CONFIG menu screen items

Item	Setting	Description
MOVIE CLIP SET		Displays the menu screen for CF memory card related settings such as formatting or deleting all recorded clip files.
DELETE ALL	●CANCEL EXECUTE	Selecting EXECUTE and pressing the SHUTTER dial deletes all clip files on the CF memory card. Protected clip files are not deleted.
FORMAT	●CANCEL EXECUTE	Selecting EXECUTE and pressing the SHUTTER dial starts formatting the card. All recorded clips are erased.
PLAY MODE	OFF  REPEAT 1 ●REPEAT	Playback is performed from the specified clip file to the latest clip file and pauses at the specified clip file. Continuously plays back the specified clip file. Playback is performed continuously from the specified clip file to the latest clip file.
PAGE BACK		Pressing the SHUTTER dial returns to the NETWORK PACK CONFIG menu screen.
MENU RESET	●CANCEL EXECUTE	Selecting EXECUTE and pressing the SHUTTER dial returns NETWORK PACK CONFIG menu screen settings to the original factory settings.
PAGE BACK		Pressing the SHUTTER dial returns to the TOP MENU screen.

## Menu screen

### Setting the NETWORK PACK CONFIG menu screen

Menu screen settings can be made regardless of whether a card is inserted. Settings will be stored in the KA-DV5000 memory even when turning the power off.

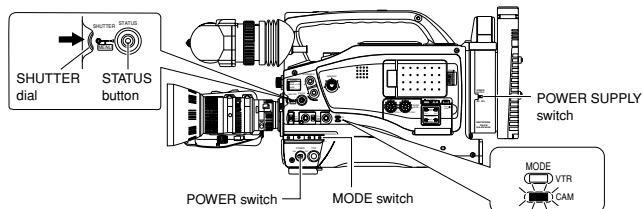

- The NETWORK PACK CONFIG menu screen will not appear during card initialization (flashing display).

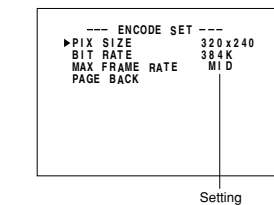
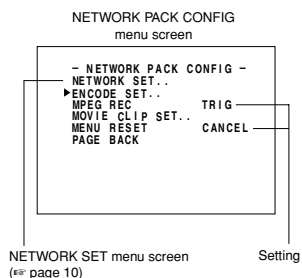
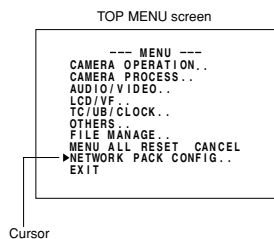

- Settings are made by viewing the LCD screen or viewfinder screen.
- If **OUTPUT CHAR** of the **OTHERS (1/2)** menu screen is set to **ON**, the menu screen also appears on the monitor screen connected to the **MONITOR OUT** or **Y/C OUT** connector.

1. Set the POWER switch of the GY-DV5000 and KA-DV5000 to ON.
2. Set the MODE switch.
  - Set to "CAM" when shooting a video. (Light the CAM indicator.)
  - Set to "VTR" for VTR playback, clip file playback or DV signal recording. (Light the VTR indicator.)
3. Press the STATUS button for about 1 seconds. The TOP MENU screen appears.
4. Turn the SHUTTER dial, move the cursor (▶) to NETWORK PACK CONFIG and press the SHUTTER dial.
  - The NETWORK PACK CONFIG menu screen appears.
5. Select the item to set.
 

Turn the SHUTTER dial, move the cursor to the desired item to set and press the SHUTTER dial.

  - The selected menu screen appears.
  - When selecting MPEG REC or MENU RESET, the setting area flashes and the setting can be changed. Set the item according to step 7.
  - When selecting NETWORK SET, the network related setting screen appears. (☞ page 10)
6. Select an item within the menu screen.
 

Turn the SHUTTER dial, move the cursor (▶) to the desired item to set and press the SHUTTER dial.

  - The setting area flashes and the setting can be changed.
7. Change the setting.
 

Turn the SHUTTER dial to change the setting and press the SHUTTER dial.

  - Flashing of the setting area stops and the new setting is confirmed.

- When changing multiple settings, repeat steps 6 and 7 above.
8. Return to the TOP MENU screen.
 

Turn the SHUTTER dial, move the cursor (▶) to PAGE BACK and press the SHUTTER dial.
  9. When quitting menu screen setting and returning to the normal screen, perform one of the following operations.
    - Press the STATUS button.
    - Move the cursor (▶) to EXIT in the TOP MENU screen and press the SHUTTER dial.

## Menu screen

### Returning the NETWORK PACK CONFIG menu screen to factory settings

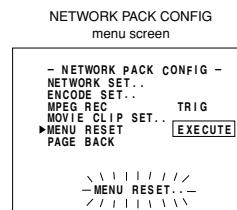
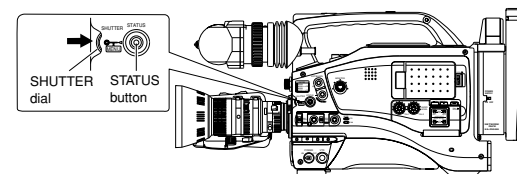

1. Press the STATUS button for about 1 seconds to display the TOP MENU screen.
2. Check to see that the card status display has changed from a flashing to constant display.
3. Turn the SHUTTER dial to select NETWORK PACK CONFIG and press the SHUTTER dial.
  - The NETWORK PACK CONFIG menu screen appears.
4. Turn the SHUTTER dial to set MENU RESET to "EXECUTE" and press the SHUTTER dial.
  - When resetting the menu, "MENU RESET." will appear at the bottom of the screen for about 5 seconds.
  - The NETWORK PACK CONFIG menu screen settings will return to the factory settings.

# Network settings

## Setting the NETWORK SET menu screen

When using a LAN card, network related settings for KA-DV5000 are made using NETWORK SET of the NETWORK PACK CONFIG menu. Settings will be stored in the KA-DV5000 memory even when turning the power off.

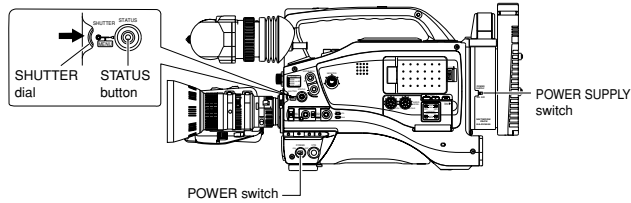

TOP MENU screen

```

--- MENU ---
CAMERA OPERATION..
CAMERA PROCESS..
AUDIO / VIDEO..
LCD / VF..
TC / UB / CLOCK..
OTHERS..
FILE MANAGE..
MENU ALL RESET CANCEL
▶NETWORK PACK CONFIG..
EXIT
    
```

NETWORK PACK CONFIG menu screen

```

- NETWORK PACK CONFIG -
▶NETWORK SET..
ENCODE SET..
MPEG REC TRIG
MOVIE CLIP SET.. CANCEL
MENU RESET
PAGE BACK
    
```

NETWORK SET [1/2] menu screen

```

--- NETWORK SET [1/2] ---
▶HOST NAME.. OFF
DHCP
IP ADDRESS..
NETMASK..
GATEWAY..
NEXT PAGE
PAGE BACK
    
```

NETWORK SET [2/2] menu screen

```

--- NETWORK SET [2/2] ---
▶RTSP..
HTTP..
WLAN AD HOC MODE OFF
WLAN ESS-ID..
WLAN CH 2CH
USER NAME..
PASS WORD..
PAGE BACK
    
```

### Settings are made by viewing the LCD screen or viewfinder screen.

If OUTPUT CHAR of the OTHERS (1/2) menu screen is set to ON, the menu screen also appears on the monitor screen connected to the MONITOR OUT or Y/C OUT connector.

### Display the NETWORK SET menu screen

1. Turn on the GY-DV5000 and KA-DV5000 power.
2. Check to see that the card status display has changed from a flashing to constant display.
3. Press the STATUS button for about 1 seconds to display the TOP MENU screen.
4. Turn the SHUTTER dial, move the cursor (▶) to NETWORK PACK CONFIG and press the SHUTTER dial.
  - The NETWORK PACK CONFIG menu screen appears.
5. Turn the SHUTTER dial, move the cursor (▶) to NETWORK SET and press the SHUTTER dial.
  - The NETWORK SET [1/2] menu screen will appear.
  - The NETWORK SET menu screen is structured by 2 pages.

### Select NEXT PAGE and press the SHUTTER dial to display the NETWORK SET [2/2] menu screen.

Select PAGE BACK in the NETWORK SET [2/2] menu screen and press the SHUTTER dial to return to the NETWORK SET [1/2] menu screen.

6. Set DHCP to ON or OFF in the NETWORK SET [1/2] menu screen. Items other than DHCP are set in the individual setting screen. (☞ page 11)
7. To return to the normal screen after completing setting, perform one of the following operations.
  - Press the STATUS button
  - Select PAGE BACK to return to the TOP MENU screen. Select EXIT in the TOP MENU screen and press the SHUTTER dial.

# Network settings

## NETWORK SET menu screen items

[1/2] screen ● indicates default factory setting.

Item	Setting	Description
HOST NAME		Displays the host name input setting screen. (Max. 63 alphanumerical characters) [Factory setting: none]
DHCP	●OFF ON	Select whether DHCP server is used. OFF: Use this setting when using LAN connection rather than DHCP. When this setting is used, IP ADDRESS and NETMASK, GATEWAY must also be set. ON: Use this setting when using DHCP connection. When using this setting, IP ADDRESS and NETMASK, GATEWAY are automatically set. * When DHCP is set to ON, WLAN ADHOC MODE cannot be set to AHDM or IBSS.
IP ADDRESS		Displays the IP address setting screen. When using LAN connection with DHCP set to OFF, this setting is required. Set a unique IP address. IP ADDRESS setting is not available when DHCP is set to ON. [Factory setting] 192.168.100.101
NETMASK		Displays the subnet mask input screen. This setting is required when using LAN connection with DHCP set to OFF. NETMASK setting is not available if DHCP is set to ON. [Factory setting: 255.255.255.000]
GATE WAY		Displays the gateway address input screen. GATEWAY setting is not available when DHCP is set to ON. [Factory setting: 192.168.100.254]
NEXT PAGE		Pressing the SHUTTER dial displays the NETWORK SET [2/2] menu screen.
PAGE BACK		Pressing the SHUTTER dial returns to the NETWORK PACK CONFIG menu screen.

[2/2] screen

Item	Setting	Description
RTSP	1 : ●8554 : 32767	The screen for setting RTSP and HTTP port numbers appears. Normally, the unit can be used without changing the factory settings. If there are port restrictions for the LAN environment of your PC, consult your network administrator. * When changing a port number, refer to "5-1. Connecting with Camcorder" of the "Streamproducer" User's Guide of the network distribution software to change settings. * Do not use the same port numbers for RTSP and HTTP.
HTTP	1 : ●80 : 32767	* When a port number is changed, switch the power of the GY-DV5000 off once, and then switch it on again.
WLAN AD HOC MODE	●OFF AHDM IBSS	Wireless LAN setting OFF: Use this setting when performing communication via access point. AHDM/IBSS: Use this setting when performing communication in AD HOC mode with a PC connected with a wireless LAN card. (☞ page 15) * When this item is set to AHDM or IBSS, DHCP cannot be set to ON.
WLAN ESS-ID		Displays the wireless LAN ESS-ID input setting screen (Max. 32 alphanumerical characters)
WLAN WEP KEY		When encrypting data, set the WEP KEY (10 characters consisting of letters a ~ f and numbers). Must be compatible with access point authentication for the use of this item.
WLAN CH	1CH ●2CH : 14CH	Wireless LAN channel setting
USER NAME		Displays the user name input setting screen. (Max. 8 alphanumerical characters) Used when controlling GY-DV5000 via LAN card. (☞ page 30) [Factory setting: jvc]
PASS WORD		Displays the password input setting screen. (Max. 8 alphanumerical characters) Used when controlling GY-DV5000 via LAN card. (☞ page 30) [Factory setting: ka-dv5k] (Password is hidden) <b>Caution</b> • Keep a memo of the password since it is only displayed during the actual setting. The password will be hidden using asterisks (*) when accessing the password menu screen again. • When performing MENU RESET, ka-dv5k will return to its factory settings. (☞ page 9)
PAGE BACK		Pressing the SHUTTER dial returns to the NETWORK SET [1/2] menu screen.

## Network settings

### USER PAGE can be customized

USER PAGE can be customized as desired.

USER PAGE created on a PC is uploaded by FTP.

1. Set the unit so that NETWORK SETUP can be displayed. (≡ page 30)
2. Create HTML on the PC using a commercially available HTML editor, etc. Save the created HTML file under the name of "index.html".
3. Use a commercially available FTP program on the PC to upload index.html created in step 2 above to KA-DV5000.  
FTP program settings  
IP Adress : 192.168.100.101 (Input the actual IP address used.)  
Remort Port : 21  
USER ID : html  
PASSWORD : None

■ It is also possible to upload link pages from index.html, images, etc.

#### Caution

- Make sure the uploaded files do not exceed 100KB in total.
- The HTML display will fit properly on the screen when creating at a size of about 500 X 360 pixels.

## Network settings

### Making network related settings

Network related settings are made in the individual input setting screens.

Here, USER NAME is set as an example. Other settings are also made in the same manner.

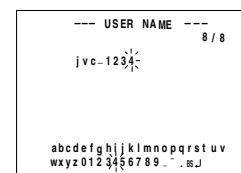
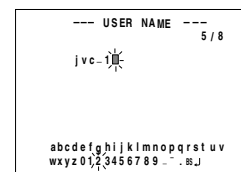
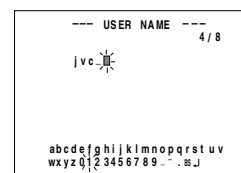
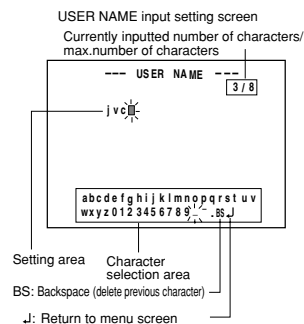
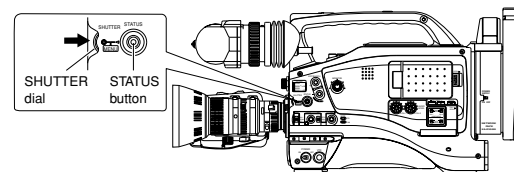

Example: Changing USER NAME from jvc to jvc-1234

■ Select **USER NAME** in the **NETWORK SET [2/2]** menu screen and press the **SHUTTER dial**.

- The USER NAME input setting screen appears.

1. Characters are selected from the character selection area on the bottom of the screen.  
Turn the SHUTTER dial to flash " \_ " in the character selection area and press the SHUTTER dial.  
• The setting changes to "jvc\_ " and the following digit of the setting area flashes.
2. Turn the SHUTTER dial to select "1" in the character selection area and press the SHUTTER dial.  
• The setting changes to "jvc\_1" and the following digit of the setting area flashes.
3. Repeat the above step to set "jvc\_1234" in the setting area.

■ To delete or edit set characters, select "BS" within the character selection area and press the SHUTTER dial.

The previous character will be deleted. The character on the left will be deleted each time this operation is repeated.

■ The currently inputted number of characters and the maximum number of characters are displayed on the upper right of the screen.

4. When completed, select "J" within the character selection area and press the SHUTTER dial.  
• NETWORK SET [2/2] menu screen returns in the LCD or viewfinder.



# Network settings

## Detailed IP settings (LAN)

Example of IP address and subnet mask settings when using LAN is shown below.

- Operation is only guaranteed for Windows 2000, Windows XP Home Edition or Windows XP Professional.
- Internet Explorer 5.0 or later
- Windows Media Player 7.01 or later

### 1. For 1:1 communication between PC and GY-DV5000/KA-DV5000

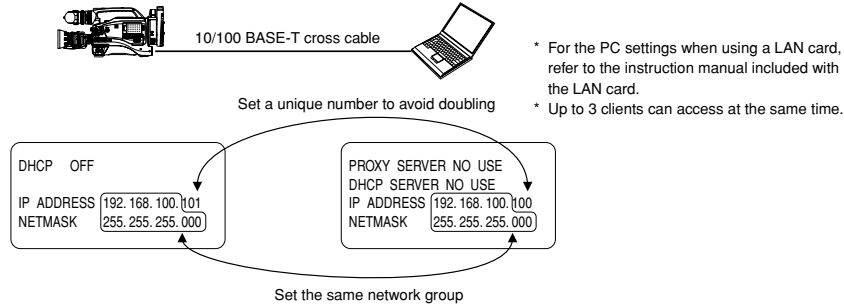

### 2. For communication between PC and multiple GY-DV5000/KA-DV5000

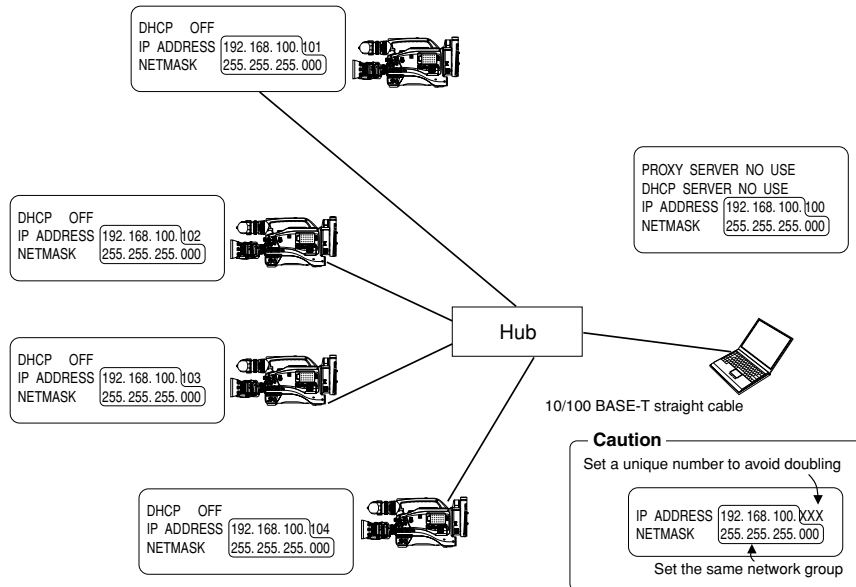

# Network settings

## Detailed network settings (WLAN)

Example of network settings when using wireless LAN is shown below.

- Operation is only guaranteed for Windows 2000, Windows XP Home Edition or Windows XP Professional.
- Internet Explorer 5.0 or later
- Windows Media Player 7.01 or later

### 1. For communication with PC without returning access point (Ad hoc mode)

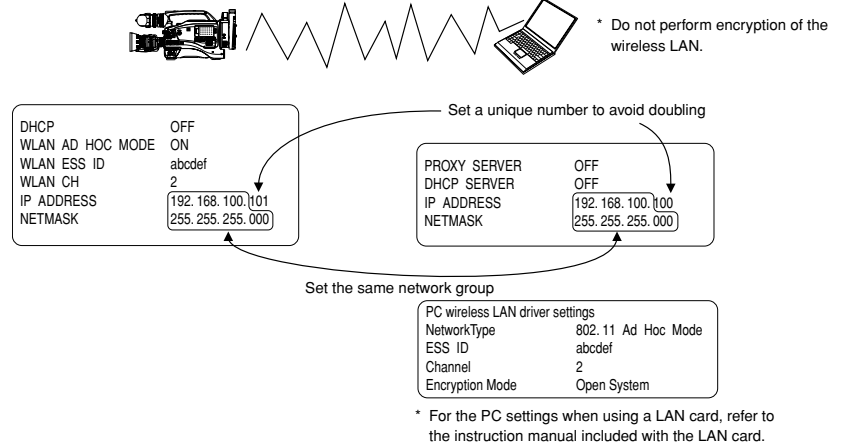

### Cautionary items concerning Wireless LAN (WLAN)

- For the WLAN ESS ID, input the values of ESSID set in:  
Ad hoc mode: PC of other party  
Infrastructure: Access point
- WLAN AD HOC MODE  
When IBSS is set, the NETWORK MODE setting of the wireless LAN card on the PC side must be set to 802.11 Adhoc.  
When AHDM is set, the NETWORK MODE setting of the wireless LAN card on the PC side must be set to Adhoc. Depending on the LAN card on the PC side, only 802.11 Adhoc mode may be available.
- WLAN CH is the wireless frequency band used for communication. If there is an access point, adapter, etc., using the same band in the proximity, there may be a hindrance in the communication and may reduce throughput or the quality of communication. When setting, check the settings of surrounding access points, etc., to avoid doubling.

Frequency bands (ISM bands) and channels (IEEE803.11b standard)

- N. America : FCC / 2.412~2.462GHz (11 channels)
- Europe : CE ETSI / 2.412~2.472GHz (13 channels)
- Japan : 2.412~2.4835GHz (14 channels)
- France : 2.457~2.472GHz (4 channels)
- Spain : 2.457~2.462GHz (2 channels)

Since adjacent channels causes signal interference, channels are normally spaced 5 channels apart.

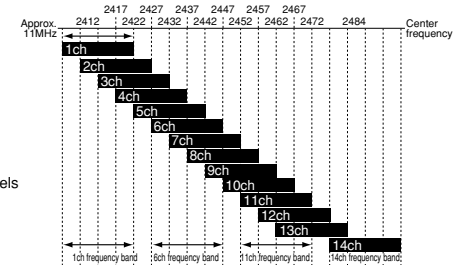

## Network settings

### Detailed network settings (WLAN)

#### 2. For communication with PC via access point (Infrastructure mode)

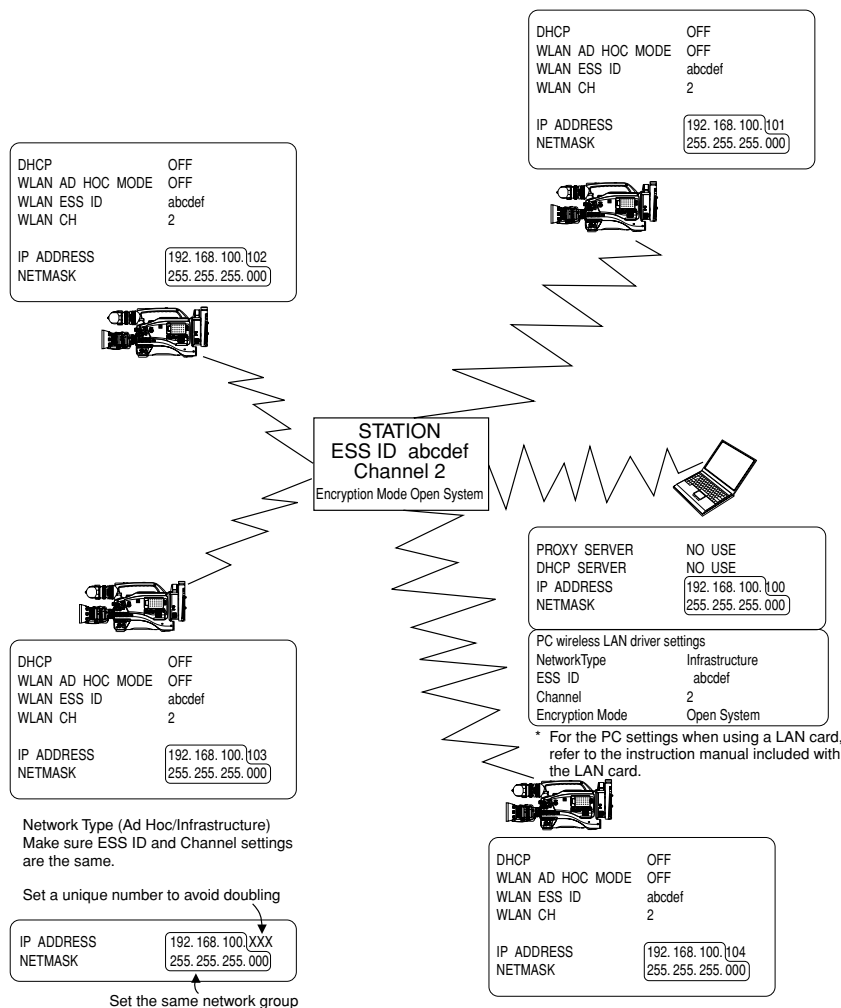

#### Memo

For network settings and LAN card driver settings, refer to the respective instruction manuals.

## Recording on a CF card

### Formatting a CF memory card

When an unformatted CF memory card is inserted and the GY-DV5000 power is turned on, "NO CF FORMAT!" appears in the LCD screen/viewfinder screen.

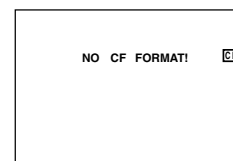
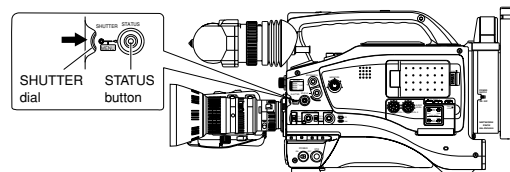

NETWORK PACK CONFIG menu screen

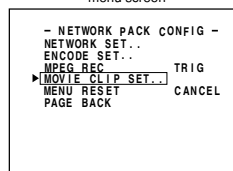

MOVIE CLIP SET menu screen

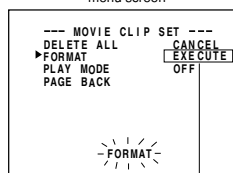

Flashing display during formatting

MOVIE CLIP SET menu screen

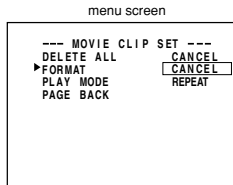

1. Press the STATUS button for about 1 seconds to display the TOP MENU screen.
2. Use the SHUTTER dial to select NETWORK PACK CONFIG menu screen → MOVIE CLIP SET menu screen.
3. Set FORMAT in the MOVIE CLIP SET menu screen to "EXECUTE" and press the SHUTTER dial.
  - The formatting begins. During formatting, "FORMAT" appears on the screen.
4. When formatting is completed, to the MOVIE CLIP SET menu screen returns. The FORMAT setting will return to CANCEL.
5. To return to the NETWORK PACK CONFIG menu screen, select PAGE BACK and press the SHUTTER dial.
  - To return to the normal screen, press the STATUS button.

#### CF memory recording time

Estimated recording time of CF memory cards is shown below:

CF memory card size	BIT RATE		
	384kbps	256kbps	128kbps ~ 56kbps
16MByte	3min.	5min.	10min. or more
32MByte	7min.	11min.	20min. or more
64MByte	15min.	22min.	40min. or more
128MByte	30min.	44min.	80min. or more
192MByte	46min.	66min.	120min. or more
256MByte	61min.	88min.	160min. or more

#### Caution

The actual recording time may differ from the estimate recording time shown above depending on the recording subject and movement.

## Recording on a CF card Recording video on a DV cassette tape and CF memory card

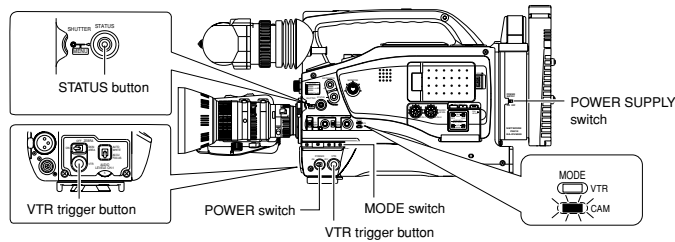

- "NO CF FORMAT!" will appear if the inserted CF memory card is not formatted. Format the card in the MOVIE CLIP SET menu screen. (☞ page 17)

LCD screen

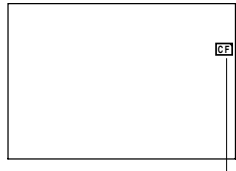

CF: Red display during recording

⏏: Initializing

NETWORK PACK CONFIG menu screen

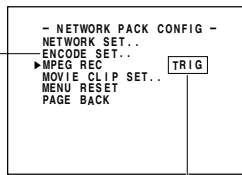

ENCODE SET menu screen

Set to TRIG

LCD screen

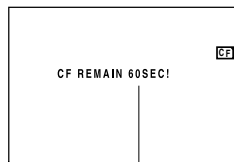

CF memory card remaining warning

1. Insert a CF memory card into the Network Pack.
2. Turn on the GY-DV5000 and KA-DV5000 power.  
Check to see that the CF display appears on the LCD screen/viewfinder screen. (When the power is turned on, ⏏ display will flash during initialization.)
3. Insert a recordable DV cassette tape.
4. Set the MODE switch to "CAM". (Light the CAM indicator.)
5. Set the NETWORK PACK CONFIG menu screen.
  - ① Set MPEG REC to "TRIG".
  - ② Set the video/audio compression in the ENCODE SET menu screen. (☞ page 6)
  - ③ When completed with settings, press the STATUS button to return to the normal screen.
6. Press the VTR trigger button on GY-DV5000 to start recording on the DV cassette tape as well as video/audio streaming data on the CF memory card.
  - During CF memory card recording, CF display will light red.
7. To stop recording, press the VTR trigger button.
8. To resume recording, press the VTR trigger button once more.
9. To end recording, press the VTR trigger button.  
\* Before turning off the power, check to make sure the CF indicator on the LCD screen is white.  
Turning the power off when the CF indicator is red will damage the recorded clip file.

### Memo

- When the DV cassette tape has reached the end during recording, CF memory card recording will also stop.
- Every time recording is performed, the recorded event is stored in the clip list of the CF memory card.  
Stored contents of clip list: Clip number and date/time when recording was started. All events can be played back on the MOVIE CLIP screen. (☞ page 22)
- The CF memory card remaining warning is displayed on the LCD screen/viewfinder screen. (☞ page 40)

## Recording on a CF card Recording video on a CF memory card only

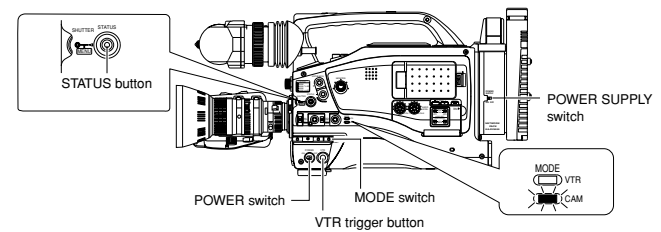

- "NO CF FORMAT!" will appear if the inserted CF memory card is not formatted. Format the card in the MOVIE CLIP SET menu screen. (☞ page 17)

LCD screen

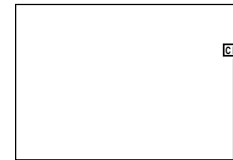

CF: Red display during recording

⏏: Initializing

NETWORK PACK CONFIG menu screen

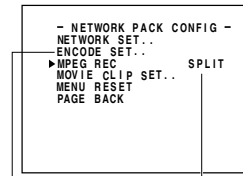

ENCODE SET menu screen

Set to SPLIT

LCD screen

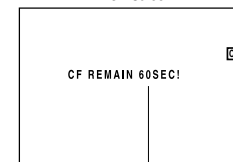

CF memory card remaining warning

1. Insert a CF memory card into the Network Pack.
2. Turn on the GY-DV5000 and KA-DV5000 power.  
Check to see that the CF display appears on the LCD screen/viewfinder screen. (When the power is turned on, ⏏ display will flash during initialization.)
3. Set the MODE switch to "CAM". (Light the CAM indicator.)
4. Set the NETWORK PACK CONFIG menu screen.
  - ① Set MPEG REC to "SPLIT".
  - ② Set the video/audio compression in the ENCODE SET menu screen. (☞ page 6)
  - ③ When completed with settings, press the STATUS button to return to the normal screen.
5. Press the VTR trigger button on side panel of GY-DV5000 to start recording streaming data on the CF memory card.
  - During recording, CF display will light red.
6. To stop recording, press the VTR trigger button on side panel.
7. To resume recording, press the VTR trigger button on side panel once more.
8. To end recording, press the VTR trigger button on side panel.  
\* Before turning off the power, check to make sure the CF indicator on the LCD screen is white.  
Turning the power off when the CF indicator is red will damage the recorded clip file.

### Memo

- Every time recording is performed, the recorded event is stored in the clip list of the CF memory card.  
Stored contents of clip list: Clip number and date/time when recording was started. All events can be played back on the MOVIE CLIP screen. (☞ page 22)
- The CF memory card remaining warning is displayed on the LCD screen/viewfinder screen. (☞ page 40)
- When MPEG REC is set to "SPLIT", recording is performed only when the VTR trigger button on the side is pressed. The VTR trigger buttons on the front and on the lens are disabled.

## Recording on a CF card Recording playback signals of a DV cassette tape on a CF memory card

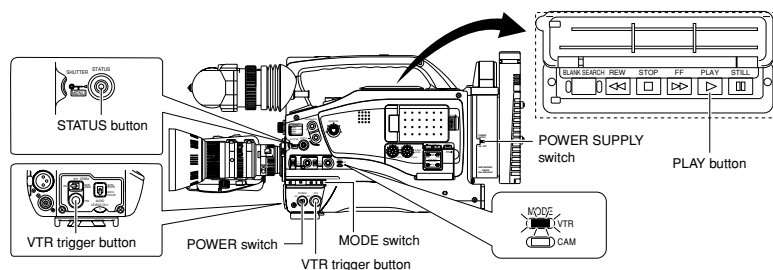

• "NO CF FORMAT!" will appear if the inserted CF memory card is not formatted. Format the card in the MOVIE CLIP SET menu screen. (☞ page 17)

1. Insert a CF memory card into the Network Pack.
2. Turn on the GY-DV5000 and KA-DV5000 power. Check to see that the [CF] display appears on the LCD screen/viewfinder screen. (When the power is turned on, [ ] display will flash during initialization.)
3. Insert the recorded DV cassette tape.
4. Set the MODE switch to "VTR". (Light the VTR indicator.)
5. Set the NETWORK PACK CONFIG menu screen.
  - ① Set MPEG REC to "TRIG". When MPEG REC is set to "SPLIT", recording is performed only when the VTR trigger button on the side is pressed.
  - ② Set the video/audio compression in the ENCODE SET menu screen. (☞ page 6)
  - ③ When completed with settings, press the STATUS button to return to the normal screen.
6. Press the PLAY button of GY-DV5000 to start DV cassette tape playback.
7. Press the VTR trigger button at the scene to start recording on the CF memory card.
  - During recording, the [CF] display appears in red.
8. To stop recording, press the VTR trigger button.
9. To resume recording, press the VTR trigger button once more.
10. To end recording, press the VTR trigger button.
  - \* Before turning off the power, check to make sure the [CF] indicator on the LCD screen is white.
  - Turning the power off when the [CF] indicator is red will damage the recorded clip file.

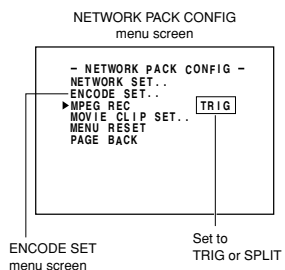
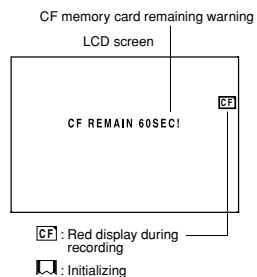

### Memo

- Every time recording is performed, the recorded event is stored in the clip list of the CF memory card. Stored contents of clip list: Clip number and date/time when recording was started. All events can be played back on the MOVIE CLIP screen. (☞ page 22)
- The CF memory card remaining time is displayed on the LCD screen/viewfinder screen.

## Recording on a CF card Deleting all clip files on a CF memory card

MOVIE CLIP of the NETWORK PACK CONFIG menu screen is used to delete all clips on a CF memory card.

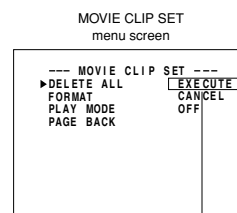
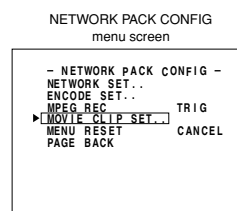
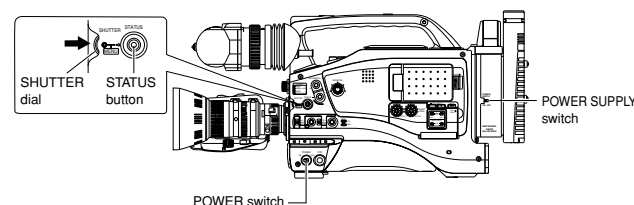

Set to EXECUTE

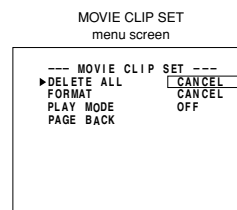
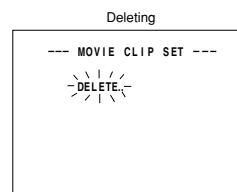

1. Insert an already recorded CF memory card.
2. Turn on the GY-DV5000 and KA-DV5000 power. Check to see that the [CF] display appears on the LCD screen/viewfinder screen. (The [ ] mark will flash when first turning on the power or during initialization.)
3. Press the STATUS button for about 1 seconds to display the TOP MENU screen.
4. Use the SHUTTER dial to select NETWORK PACK CONFIG menu screen → MOVIE CLIP SET menu screen.
5. Set DELETE ALL in the MOVIE CLIP SET menu screen to "EXECUTE" and press the SHUTTER dial.
  - Deletion is executed and "DELETE.." appears flashing on the screen.
6. When deletion is completed, to the MOVIE CLIP SET menu screen returns. DELETE ALL setting will return to "CANCEL".
7. ■ To return to the NETWORK CONFIG menu screen, select PAGE BACK and press the SHUTTER dial.
  - To return to the normal screen, press the STATUS button.

### Memo

- Protected clips are not deleted.

## Movie clip

### Playing back video/audio recorded on a CF memory card

Every time recording is performed, the recorded event is stored in the clip list of the CF memory card. The clip list is stored with the recorded event number (clip number) and the date/time when the recording was started. All events (clip numbers) can be played back on the MOVIE CLIP screen.

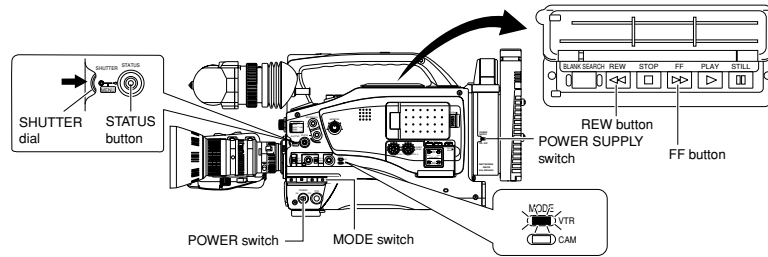

- MOVIE CLIP will not appear during card initialization (flashing display).

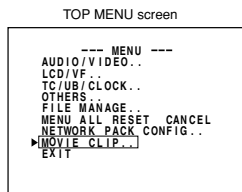

1. Insert an already recorded CF memory card.
2. Turn on the GY-DV5000 and KA-DV5000 power. Check to see that the display appears on the LCD screen/viewfinder screen. (When the power is turned on, display will flash during initialization.)
3. Set the MODE switch to "VTR". (Light the VTR indicator.)
4. Make sure GY-DV5000 is not in operation.
5. Display the MOVIE CLIP screen.
  - ① Press the STATUS button for about 1 seconds to display the TOP MENU screen.
  - ② Turn the SHUTTER dial, move the cursor (▶) to MOVIE CLIP and press the SHUTTER dial.
    - The movie clip list of the latest clip page recorded on the CF memory card and the still image (starting point) of the latest clip number appear by overlapping.

#### Memo

When a MOVIE CLIP menu item is selected and the SHUTTER dial is pressed with no clips recorded on the CF memory card, "NO CLIP!" will flash for about 3 seconds.  
If there is no CF memory card inserted, "NO CF CARD!" will flash for about 3 seconds.

#### MOVIE CLIP screen

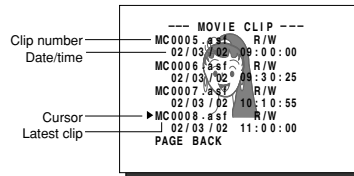

The clip page in the MOVIE CLIP screen displays 4 lists per page.

6. Select the clip to play back.
  - ① Turn the SHUTTER dial and move the cursor (▶) to the clip to play back.
    - Turning the SHUTTER dial up scrolls to the page with smaller (older) clip numbers.
    - Turning the SHUTTER dial down scrolls to the page with larger (newer) clip numbers.
    - Press the [FF] button to scroll to the next page. Press the [REW] button to scroll to the previous page.
    - Press and hold the [FF] button for about 2 seconds to scroll to the page with the newest clip.
    - Press and hold the [REW] button for about 2 seconds to scroll to the page with the oldest clip.
  - ② Press the SHUTTER dial. CLIP FUNCTION screen of the selected clip appears.
    - Still image (starting point) of the selected clip appears.

#### Note

ASF files recorded using another device may not play back properly on this unit.

→ OVER

## Movie clip

### Playing back video/audio recorded on a CF memory card

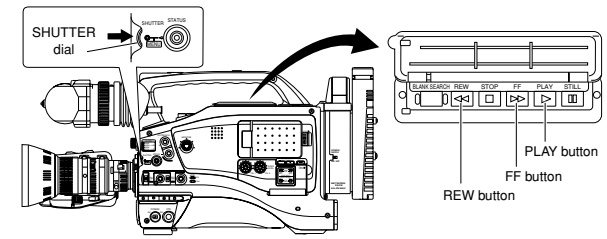
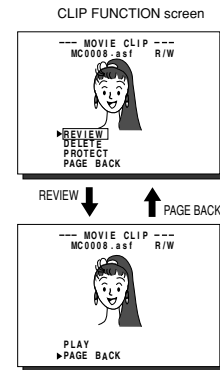

7. Play back the clip. Turn the SHUTTER dial, move the cursor to REVIEW and press the SHUTTER dial.
  - The movie clip is played back after the still image is displayed for about 1 second. The value of the recorded pixel size (320 × 240 or 160 × 120) appears during displaying the still image. The value of the recorded max. bit rate appears during playback.
8. To pause playback, press the PLAY button.
9. To resume playback, press the PLAY button once more.
10. The following operations are performed when the playback of the selected clip ends. (When PLAY MODE in the MOVIE CLIP SET screen is set to "OFF")
  - When there are no following clips, the unit pauses at the beginning of the current clip.
  - When there are following clips, the unit displays the still image of the next clip for about 1 second, then starts playback. When all remaining clips are played back, the unit pauses at the beginning of the played back clip.

■ Selecting PAGE BACK during playback or pausing and press the SHUTTER dial will return to the MOVIE CLIP screen.

#### Memo

- The video encoded by the KA-DV5000 is so designed that it is displayed in a correct aspect ratio by personal computer monitor. When the CF played-back video is viewed by video-out connector output of the GY-DV5000 or observed on a liquid crystal monitor screen, the aspect ratio may look different. This is because a simple output is made on the video for a personal computer and is therefore normal and not a malfunction.
- When PLAY MODE in the MOVIE CLIP SET screen is set to "REPEAT", repeat playback is performed. (⇨ page 7)

#### To move to another clip during playback

- Playback will remain on the current clip even when the FF button is pressed if the latest clip is being played back.
  - Pressing the REW button during play back of the oldest clip will start playback at the starting point of the that clip.
- To move to the next clip during middle of playback or pausing, press the FF button of GY-DV5000.
- The playback of the current clip stops and the unit pauses at the starting point of the next clip. Pressing the FF button again pauses at the starting point of the following the next clip.
- To move to the previous clip during middle of playback or pausing, press the REW button of GY-DV5000.
- The playback of the current clip stops and the unit pauses at the starting point of the previous clip. Pressing the REW button again pauses at the starting point of the clip before the previous clip.
- To move to the latest clip during middle of playback or pausing, press the FF button of GY-DV5000 for more than 2 seconds.
- The unit pauses at the starting point of the latest clip. To start playback, press the PLAY button.
- To move to the oldest clip during middle of playback or pausing, press the REW button of GY-DV5000 for more than 2 seconds.
- The unit pauses at the starting point of the oldest clip. To start playback, press the PLAY button.

## Movie clip

### Protecting a clip file on a CF memory card

Clips recorded on a CF memory card can be protected using the MOVIE CLIP screen.

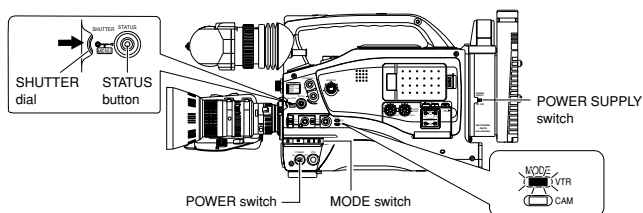

- When executing FORMAT in the MOVIE CLIP SET menu screen, protected clips will also be deleted.
- Protected clips will not be deleted even when executing DELETE ALL in the MOVIE CLIP SET menu screen.

1. Insert an already recorded CF memory card.
2. Turn on the GY-DV5000 and KA-DV5000 power. Check to see that the [CF] display appears on the LCD screen/viewfinder screen. (When the power is turned on, [CF] display will flash during initialization.)
3. Set the MODE switch to "VTR". (Light the VTR indicator.)
4. Make sure GY-DV5000 is not in operation.
5. Display the MOVIE CLIP screen.
  - ① Press the STATUS button for about 1 seconds to display the TOP MENU screen.
  - ② Turn the SHUTTER dial, move the cursor (▶) to MOVIE CLIP and press the SHUTTER dial.
    - The latest page of the MOVIE CLIP screen appears.
    - R/W display appears on the right of the clip number.
6. Select the clip to protect. Turn the SHUTTER dial, move the cursor (▶) to the clip to protect and press the SHUTTER dial.
  - The CLIP FUNCTION screen of the selected clip appears.
7. Turn the SHUTTER dial, move the cursor to PROTECT in the CLIP FUNCTION screen and press the SHUTTER dial.
  - The selected clip is protected.
  - The R/W display on the right of the clip number will change to an R display.

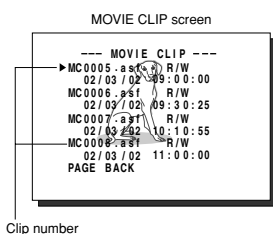
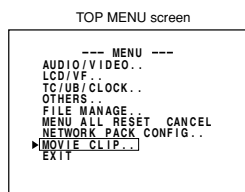

Clip number

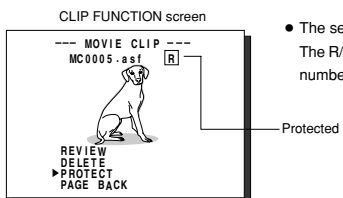

Protected

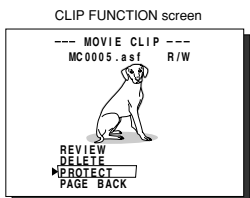

8. To return to the MOVIE CLIP screen after completing setting, select PAGE BACK and press the SHUTTER dial.
  - To cancel the protection, select PROTECT in the CLIP FUNCTION screen and press the SHUTTER dial.
    - The R display will change to an R/W display and the protection on the clip will be canceled.

## Movie clip

### Deleting a clip file on a CF memory card

Clips recorded on a CF memory card can be deleted using the MOVIE CLIP screen.

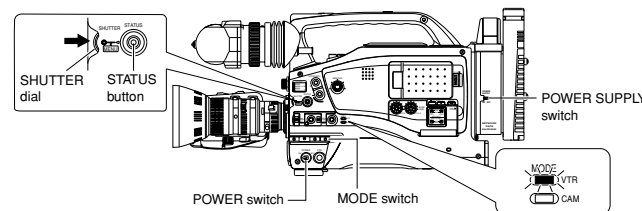

1. Insert an already recorded CF memory card.
2. Turn on the GY-DV5000 and KA-DV5000 power. Check to see that the [CF] display appears on the LCD screen/viewfinder screen. (When the power is turned on, [CF] display will flash during initialization.)
3. Set the MODE switch to "VTR". (Light the VTR indicator.)
4. Make sure GY-DV5000 is not in operation.
5. Display the MOVIE CLIP screen.
  - ① Press the STATUS button for about 1 seconds to display the TOP MENU screen.
  - ② Turn the SHUTTER dial, move the cursor (▶) to MOVIE CLIP and press the SHUTTER dial.
    - The latest page of the MOVIE CLIP screen appears.
6. Select the clip to delete. Turn the SHUTTER dial, move the cursor (▶) to the clip to delete and press the SHUTTER dial.
  - The CLIP FUNCTION screen of the selected clip appears.
7. Turn the SHUTTER dial, move the cursor to DELETE in the CLIP FUNCTION screen and press the SHUTTER dial.
  - A "DELETE OK?" confirmation message appears. (Confirmation screen)
8. To delete, select YES using the SHUTTER dial and press the SHUTTER dial.
  - "DELETE ." flashes on the screen for about 5 seconds and then the MOVIE CLIP screen returns. The clip is deleted from the MOVIE CLIP screen.
  - To cancel the deletion, select PAGE BACK and press the SHUTTER dial.

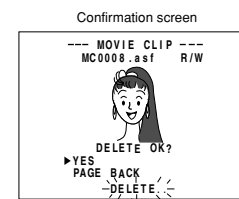
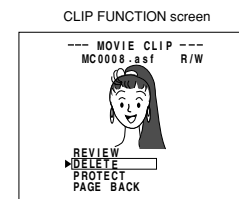
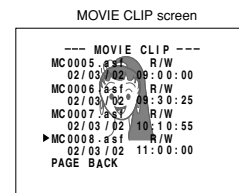
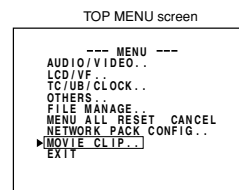

Deleting Flashing display

#### Memo

- Protected clips cannot be deleted even when selecting DELETE. In this case, "PROTECT!" will flash for about 2 seconds and then CLIP FUNCTION screen returns.
- After deleting a clip and there are no remaining clips left on the CF memory card, "NO CLIP!" flashes on the screen for about 3 seconds and then the TOP MENU screen returns.
- To delete all clips, use the MOVIE CLIP SET in the NETWORK PACK CONFIG menu screen. (☞ page 21)

## Movie clip

### Playing back CF memory card clips on your PC

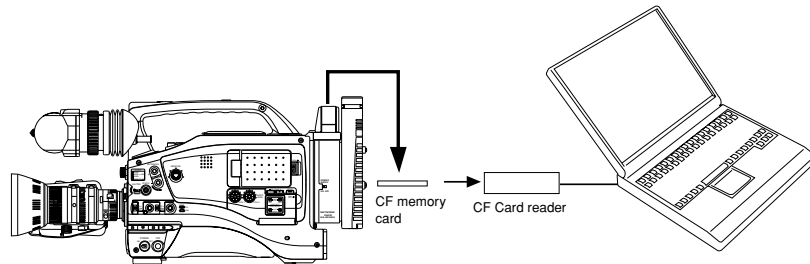

Clips recorded on a CF memory card can be played back on your PC.

\* If the PC is equipped with PCMCIA slot(s), CF card reader is not required.

#### Caution

- Clips recorded on CF memory cards are stored in ASF file format.
  - To play back a clip on your PC, Windows Media Player 7.01 is required.
  - \* Windows Media Player is compatible with Windows XP or Windows 2000/98(SE)/Me operating system.
  - \* Media Player can be downloaded from the Microsoft Website.
- During this time, download the following codec software as well.
- The codec software is automatically downloaded when opening the clip file and running Windows Media Player.
- Video codec (decoder) ISO MPEG4
  - Audio codec (decoder) G.726

#### Operation

1. Load data already recorded on a CF memory card to your PC using a CF card reader, etc.
2. Launch Explorer, etc., and open the recorded clip file in ASF format.
  - Windows Media Player launches and the clip is played back.

#### Memo

Video and audio files (clip files) in CF memory cards can be appended to email as attachment files.

## LAN card

### Sending video using LAN card while recording on a DV cassette tape

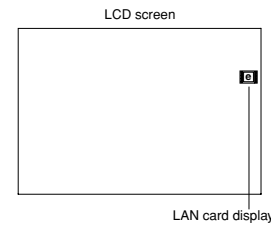
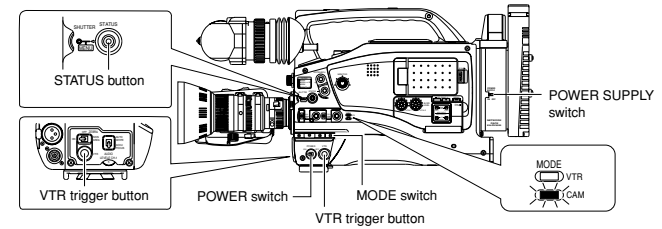

No LAN card is inserted when the  display appears. Turn off the power and insert a LAN card. Then, turn the power back on.

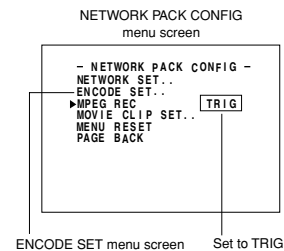

1. Insert a LAN card into the Network Pack.
2. Turn on the GY-DV5000 and KA-DV5000 power.  
Check to see that the LAN card display is showing on the LCD screen/viewfinder screen.
3. Set the MODE switch to "CAM". (Light the CAM indicator.)
4. Insert a recordable DV cassette tape.
  - GY-DV5000 will be in the standby mode.
5. Set the NETWORK PACK CONFIG menu screen.
  - ① Set MPEG REC to "TRIG".
  - ② Set the video/audio compress in the ENCODE SET menu screen. (see page 6)
  - ③ When completed, press the STATUS button to return to the normal screen.
6. When pressing the VTR trigger button of GY-DV5000 while Streamproducer is in operation\*, transmission of video/audio streaming data from the LAN card is started simultaneously with recording to DV cassette tape.
  - The LAN card display on the LCD screen/viewfinder screen will be as follows: : Red display during data transmission.
  - \* Perform setting described in "5-2 Operating video from DV camcorder • Trigger mode function" of network distribution software "Streamproducer" User's Guide.
7. To stop transmission or recording, press the VTR trigger button.
  - GY-DV5000 will be in the standby mode.
8. To resume transmission or recording, press the VTR trigger button once more.
9. To end, press the VTR trigger button to stop transmission and recording and turn off the power.  
Lastly, remove the LAN card.

#### Memo

- Streaming data will be sent from the LAN card even when a DV cassette tape is not inserted.
- When the DV cassette tape reaches the end during recording, the transmission of streaming data from the LAN card is also stopped.



## LAN card Sending video using a LAN card (no DV cassette tape recording)

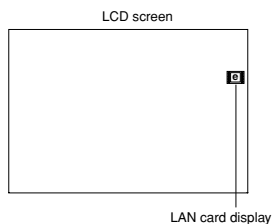
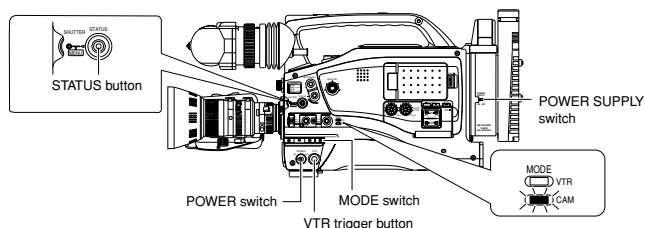

No LAN card is inserted when the  display appears. Turn off the power and insert a LAN card. Then, turn the power back on.

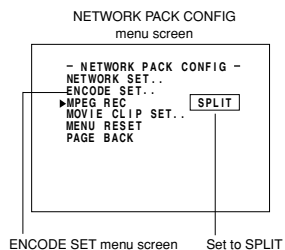



1. Insert a LAN card into the Network Pack.
2. Turn on the GY-DV5000 and KA-DV5000 power.  
Check to see that the LAN card display is showing on the LCD screen/viewfinder screen.
3. Set the MODE switch to "CAM". (Light the CAM indicator.)
4. Set the NETWORK PACK CONFIG menu screen.
  - ① Set MPEG REC to "SPLIT".
  - ② Set the video/audio compress in the ENCODE SET menu screen. (⇨ page 6)
  - ③ When completed, press the STATUS button to return to the normal screen.
5. When operating Streamproducer and making network connection with KA-DV5000, sending of streaming video/audio data will start from the LAN card.  
When pressing the VTR trigger button on the side of GY-DV5000, recording to the HDD will start.
  - The LAN card display on the LCD screen/viewfinder screen will be as follows:  
: Red display during data transmission.
  - \* Perform setting described in "5-2 Operating video from DV camcorder • Trigger mode function" of network distribution software "Streamproducer" User's Guide.
6. To stop recording to the HDD, press the VTR trigger button on the side.
7. Press the VTR trigger button on the side to resume recording to the HDD.
8. To end operation, stop the transmission by disconnecting the network connection with KA-DV5000 using Streamproducer, then turn off the power.  
Lastly, remove the LAN card.

### Memo

- When MPEG REC is set to "SPLIT", sending is performed only when the VTR trigger button on the side is pressed. The VTR trigger buttons on the front and on the lens are disabled.
- Recording will not be made on the DV cassette tape even if a tape is inserted.

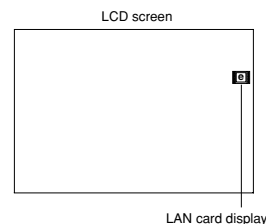
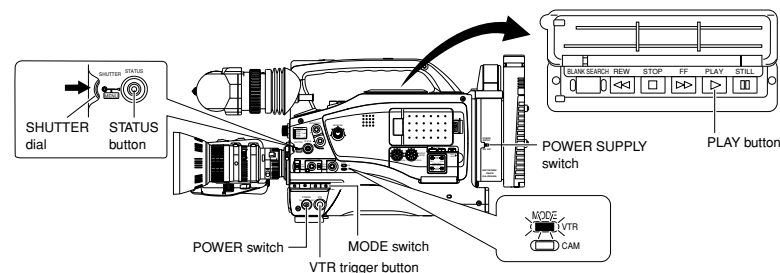
## LAN card Sending playback signals of a DV cassette tape using a LAN card



No LAN card is inserted when the  display appears. Turn off the power and insert a LAN card. Then, turn the power back on.

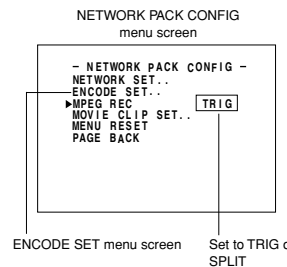

1. Insert a LAN card into the Network Pack.
2. Turn on the GY-DV5000 and KA-DV5000 power.  
Check to see that the LAN card display is showing on the LCD screen/viewfinder screen.
3. Set the MODE switch to "VTR". (Light the VTR indicator.)
4. Insert the recorded DV cassette tape.
5. Set the NETWORK PACK CONFIG menu screen.
  - ① Set MPEG REC to "SPLIT".
  - ② Set the video/audio compression in the ENCODE SET menu screen. (⇨ page 6)
  - ③ When completed with settings, press the STATUS button to return to the normal screen.
6. When operating Streamproducer and making network connection with KA-DV5000, sending of streaming video/audio data will start from the LAN card.
  - The LAN card display on the LCD screen/viewfinder screen will be as follows:  
: Red display during data transmission.
  - \* Perform setting described in "5-2 Operating video from DV camcorder • Trigger mode function" of network distribution software "Streamproducer" User's Guide.
7. Press the PLAY button of GY-DV5000 to start DV cassette tape playback.
8. Press the VTR trigger button on the side at the scene to start HDD recording with Streamproducer.
9. To stop recording to the HDD, press the VTR trigger button on the side.
10. Press the VTR trigger button on the side to resume recording to the HDD.
11. To end operation, first disconnect the network connection and then turn off the power. Lastly, remove the LAN card.

# Network pack setup

## Controlling GY-DV5000/KA-DV5000 via LAN card

With the Network Pack, GY-DV5000/KA-DV5000 can be controlled via LAN.

It is also possible to playback video and audio from KA-DV5000 on your PC in the STREAMCAPTURE screen in realtime (live display) as well as save data to files. However, note that video and audio from KA-DV5000 can be played back only on one PC at a time.

Peer-to-peer connection that directly connects the unit with a PC is explained here.

- There are the 3 types of users for Web access:
- Users referred as "jvc" (can be changed) that can perform all operations, "ENCODE" users that can view all data but only change the encoding settings, and "BROWSE" users that can only view data.
- The default password for each user type is "ka-dv5k" for "jvc" users, first 4 characters of the password set for "jvc" users for "ENCODE" users (default is "ka-d") and fixed password of "ka-dv" for "BROWSER" users.
- The following is an explanation when login is made a user permitted with all operations. In the case of other users, the OK button and Cancel button will be disabled even if operations on the screen are allowed.

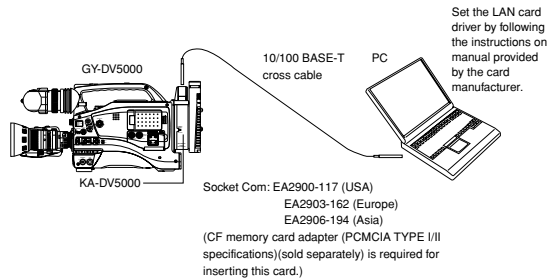

1. Turn your PC and GY-DV5000 and KA-DV5000 power off.
2. Insert the PCMCIA LAN card to specify into KA-DV5000.
3. Connect the unit and PC using a 10/100 BASE-T cross cable.
4. Turn the PC and GY-DV5000 and KA-DV5000 power on.
5. Insert a recordable DV cassette tape.
6. PC settings
  - Set the LAN card driver according to the manual provided by the card manufacturer.
  - Network settings (☞ page 13)
    - ① Set the following items in the TCP IP properties:
      - \* DHCP server is not used.
      - IP address: 192.168.100.101
      - Subnet mask: 255.255.255.000
    - ② Setting the proxy server.
      - Set the proxy server using the "LAN SETTINGS" of Windows.
      - When using peer-to-peer communication that directly connects the PC and KA-DV5000, deselect the "Use a proxy server" checkbox.
      - When the "Use a proxy server" setting must be enabled due to a LAN environment (in-company LAN, etc.), click "Advanced..." and input the IP address of GY-DV5000 in "Exceptions" of the "Use a proxy server" setting. (☞ "About proxy servers," Page 45)
7. Launch the browser on your PC and enter 192.168.100.101 (default factory setting) in the address bar and press ENTER.
  - A confirmation window for user ID and password appears.



8. Input the user ID and password.
  - ① For the user ID, input "jvc" (factory setting). For the password, input "ka-dv5k" (factory setting) or the name set in the NETWORK SET [2/2] menu screen. (☞ page 10)
  - ② Check to make sure the inputted user ID and password are correct and click the OK icon. (Check "Save password" so that the password does not need to be inputted for future accesses.)
9. If the user ID and password are correct, the NETWORK PACK SETUP screen appears on the PC monitor.
  - GY-DV5000/KA-DV5000 settings and operations can be controlled using the NETWORK PACK SETUP. (☞ page 31)

### Caution

- When setting the NETWORK PACK SETUP screen (CAM & VTR CONTROL, NETWORK SETUP, PORT SETUP or ENCODE PARAMETERS) and the same menu screen is displayed on the LCD screen or viewfinder of GY-DV5000, values set in the NETWORK PACK SETUP screen will not appear on menu screen of the LCD screen or the viewfinder of GY-DV5000. The values set in the NETWORK PACK SETUP screen will appear after the menu screen of GY-DV5000 is closed once and reopened.
- During camera/VTR control, noise may be heard from the speakers. However, this is not a malfunction. If the noise becomes irritating, open the "Sound & Multimedia" property from the Windows Control Panel and set the sound of "Windows Explorer Start Navigation" of "Sound Events" to off. \* For setting details, see Windows' Help.
- Check to make sure that NET REMOTE in the OTHERS [1/2] menu screen of GY-DV5000 is set to "ON". Camera control will not be available when NET REMOTE is set to "OFF".
- Depending on the cache setting of your browser, the parameters updated in the Camera menu may not be effective immediately.

# Network pack setup

## CAM & VTR CONTROL screen

When the correct user ID and password are accepted, the following Streamcorder screen appears.

In the CAM & VTR CONTROL screen, camera adjustments of GY-DV5000 and VTR controls can be made.

### Camera Control

#### Setting range

- When setting AUTO to ON, items other than LOLUX will not be available.
- When setting BARS to ON, items other than AUTO and LOLUX will not be available.
- When setting GAIN to ALC, IRIS and SHUTTER will not be available.

Item	Adjustment mode	Setting/description
AUTO		ON: Auto mode on. Items other than LOLUX cannot be set. OFF: Auto mode off
BARS		ON: Color bar signals are outputted. Items other than AUTO and LOLUX cannot be set. OFF: Color bar signals are not outputted.
WHITE BAL		FAW: Full white balance mode PRESET: White balance will be in the preset state. (3200K) MEMORY A, B: White balance setting stored in the GY-DV5000 memory will be used.
IRIS	AUTO	Auto iris mode. Iris will be adjusted within the following range: [-3, -2, -1, 0, +1, +2, +3]
	MANUAL	Manual iris mode. Iris will be adjusted within the following range: [CLOSE, F16, F11, F8, F5.6, F4, F2.8, F2, OPEN]
Lolux	ON OFF	Lolux mode
GAIN	ALC	ALC (Auto Level Control) mode. IRIS and SHUTTER cannot be set
	STEP	Gain can be set within the following range. 0dB is not available. [-3dB ~ 18dB]
	0dB	0dB (Sensitivity is not increased)
SHUTTER	STEP	Shutter speed can be set within the following range: U model: [1/7.5, 1/15, 1/30, 1/100, 1/250, 1/500, 1/1000, 1/2000, 1/4000, 1/10000] E model: [1/6.25, 1/12.5, 1/25, 1/120, 1/250, 1/500, 1/1000, 1/2000, 1/4000, 1/10000]
	OFF	Shutter speed will be 1/60 (1/50). ( ) : for E model
	V-SCAN	Although this setting can be canceled, future settings of this item will not be allowed.

## Network pack setup

### CAM & VTR CONTROL screen

#### ■ VTR Control



#### VTR control icons

Click each button to perform operation.

#### ■ To control the VTR in the Streamcorder screen, the following menu items of GY-DV5000 must be set in advance.

OTHERS [1/2] menu screen

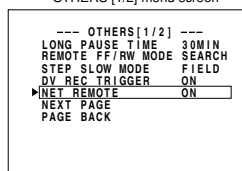

- Set NET REMOTE in the OTHERS [1/2] menu screen to ON. When set to OFF, the VTR cannot be controlled from the Streamcorder screen.

#### ■ VTR control icon operations by MODE switch settings of GY-DV5000 are as follows:

—: Mode will not change

GY-DV5000 state		Clicking VTR control icon					
MODE switch	Previous mode	REC	REW	STOP	FF	PLAY	PAUSE/STILL
VTR	STOP	REC	REW	—	FF	PLAY	—
	FF	—	REW	STOP	—	PLAY	—
	REW	—	—	STOP	FF	PLAY	—
	PLAY	—	REV SEARCH	STOP	FWD SEARCH	—	STILL
	STILL	—	—	STOP	—	PLAY	—
CAM	STOP	REC	REW	—	FF	—	—
	REC	—	—	STOP	—	—	STBY
	STBY	REC	—	STOP	—	—	—

## Network pack setup

### NETWORK SETUP screen

Clicking NETWORK SETUP on the left of the Streamcorder screen displays the NETWORK SETUP screen for performing network related settings.



Contact your network administrator for any unclear points concerning network settings.

Item	Description	Factory setting
Host Name	The host name can be set. (Max: 63 alphanumeric characters)	none
Domain Name	The domain name can be entered. (Max: 63 alphanumeric characters)	none
IP Address	The IP address can be set. (☞ page 11)	192.168.100.101
Subnet Mask	The subnet mask can be set. (☞ page 11)	255.255.255.000
Default Gateway	The gateway address can be set. (☞ page 11)	192.168.100.254
DNS server	The address of the domain name system server can be set.	0.0.0.0
Wireless LAN	Settings concerning wireless LAN can be made (☞ page 11) ●AD-HOC MODE: Ad-hoc mode IBSS/AHDM/OFF ●WLAN CH: Wireless LAN channel ●ESS-ID: Network identification name (Max: 32 alpha numerical characters) ●WEP: 64bit, 128bit, OFF ●WEP Key: Allowed characters: 10 characters consisting of 0 ~ 9, a ~ f, A ~ F	OFF 2 ch

#### Caution

If the IP address is changed in the Streamcorder screen, the unit will automatically jump to the new IP address. However, the screen may not be displayed correctly depending on the environment. In this case, access by specifying the new IP address using a browser. (☞ operation 7. on pages 30)

# Network pack setup

## PORT SETUP screen

Clicking PORT SETUP on the left of the Streamcorder screen displays the PORT SETUP screen for performing port settings.

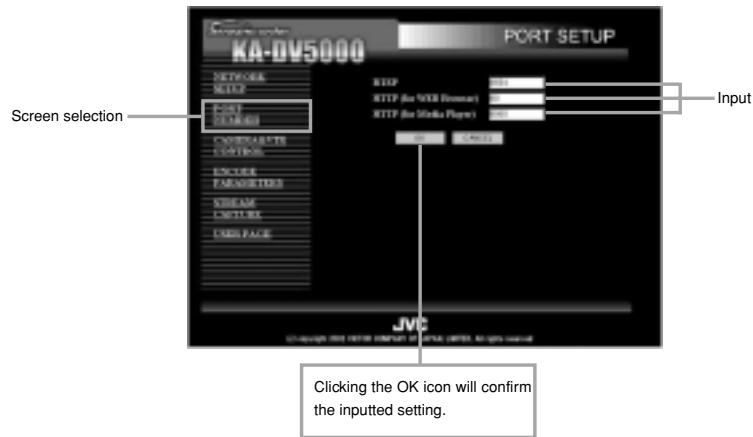

Item	Description	Factory setting
RTSP	The RTSP port can be set. (1 to 32767)	8554
HTTP (for WEB Browser)	The HTTP port for WEB browser can be set. (1 to 32767)	80
HTTP (for Media Player)	The HTTP port for Media player can be set. (1 to 32767)	8000

\* Changing ports require special knowledge. Always consult the administrator of the connecting network when making changes.  
 \* Do not use the same port numbers for RTSP and HTTP.

### Caution

If the port is changed in the Streamcorder screen, the unit will automatically jump to the new port. However, the screen may not be displayed correctly depending on the environment. In this case, access by specifying the new port using a browser. (E<sup>2</sup> operation 7. on pages 30)

# Network pack setup

## ENCODE PARAMETERS screen

Clicking ENCODE PARAMETERS on the left of the Streamcorder screen displays the ENCODE PARAMETERS screen for performing video/audio compression settings.



### Setting range

● indicates default factory setting.

Item	Setting	Description
Frame Size	● 320 × 240 160 × 120	Sets the video compression size. 320 × 240: Sets the image size to 320 × 240 pixels. (SIF) 160 × 120: Sets the image size to 160 × 120 pixels. (QSIF) (1/4 image size of SIF.)
Bit Rate	56K (bps) 128K (bps) 256K (bps) ● 384K (bps) 512K (bps)	Sets the video streaming speed.
MAX FRAME RATE ( ) : for E model	MAX ● MID MIN	Sets the frame rate per second. Settings are as shown below.

BIT RATE (bps)		PIX SIZE					
		320 × 240			160 × 120		
		MAX	MID	MIN	MAX	MID	MIN
512K	NTSC	15	10	7.5	30	15	10
	PAL	12.5	5	5	25	12.5	12.5
384K	NTSC	15	10	7.5	30	15	10
	PAL	12.5	5	5	25	12.5	6.5
256K	NTSC	15	7.5	5	30	15	7.5
	PAL	12.5	5	5	25	12.5	5

BIT RATE (bps)		PIX SIZE					
		320 × 240			160 × 120		
		MAX	MID	MIN	MAX	MID	MIN
128K	NTSC	7.5	5	3	15	10	7.5
	PAL	5	5	1	12.5	12.5	5
56K	NTSC	3	1	1	10	7.5	5
	PAL	1	1	1	12.5	5	5

## Network pack setup STREAMCAPTURE screen (Playing back video/audio using a PC and saving to file)

Clicking STREAMCAPTURE on the left of the Streamcorder screen displays the Streamcapture screen shown below.

Video and audio sent from KA-DV5000 via LAN can be played back on your PC in the Streamcapture screen or data can be saved to files. It can be used on a PC that has Streamproducer installed.

\* Since video on the STREAMCAPTURE screen is converted video data, images will take more time to appear than the actual video taken with GY-DV5000.



**Video display**  
The display size can be changed in the Property dialog box.  
(☞ page 39)

**Status/Time elapsed display**

- The current status is displayed.

VIEWING: Video or audio from KA-DV5000 is being played back in realtime (live display).  
CAPTURING: Video or audio is being saved in your PC.  
STOP: Playback is stopped.  
WAITING: TRIG recording standby.

Clicking the button will display the Property dialog box.  
Video display size and the save destination folder can be changed. (☞ page 39)

**Operation buttons** — Clicking will start operation. When on, the button will light.

VIEW	Click to play back or stop video/audio from KA-DV5000 on your PC. (ON when the Streamcapture screen is opened.)
CAPTURE	Click to save video or audio to a PC. <b>Default destination</b> My Document\Streamcorder (¥IPAddress) <b>Saved file name:</b> The file name based on the capture start time will be used. 2 0 0 2 0 3 0 4 - 1 5 3 0 0 0 .asf Year Month Day Hour Minute Second
CAPTURE-TRIG.	Click when saving the video/audio from KA-DV5000 to your PC when starting recording with GY-DV5000. (☞ page 37)
CAST-CAM	Click when sending the video/audio from KA-DV5000 to another PC. (☞ page 37)
CAST-BARS	Click when transmitting color bars rather than video from KA-DV5000. (Video from KA-DV5000 will be displayed in the video display of the Streamcapture screen. Color bars will not be displayed.)
CAST-TRIG.	Click when sending the video/audio from KA-DV5000 to another PC when starting recording with GY-DV5000. (☞ page 37)
MUTE	Click to turn on/off the mute setting. When on, the playback sound will be muted.

## Network pack setup STREAMCAPTURE screen (Playing back video/audio using a PC and saving to file)

### About the Trigger Mode function (TRIG)

The Trigger Mode function can be used to save and transmit video/audio from KA-DV5000 to your PC by synchronizing to the button operations of GY-DV5000.

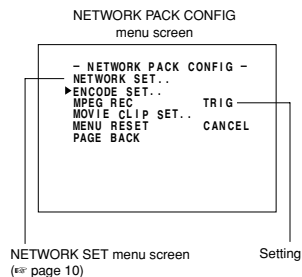

- Set MPEG REC in the NETWORK PACK CONFIG menu to "TRIG" or "SPLIT" using steps 1 ~ 9 of page 8.
  - TRIG: Records/transmits video/audio streaming data to your PC at the same time as the recording to the DV cassette tape set in GY-DV5000.
  - SPLIT: Records/transmits video/audio streaming data to your PC regardless of whether the DV cassette is set.
- Click the CAPTURE-TRIG./CAST-TRIG. button in the Streamcapture screen.
  - Button lights and the program enters the trigger standby mode.

**Memo**

- When the CAPTURE-TRIG. button is on: Saves the video/audio from KA-DV5000 to your PC by synchronizing to the button operations of GY-DV5000.
- When the CAST-TRIG. button is on: Transmits video/audio from KA-DV5000 to another PC by synchronizing to the button operations of GY-DV5000.
- When saving and transmitting video/audio at the same time, light both CAPTURE-TRIG. and CAST-TRIG. buttons.

- Press the VTR trigger button of GY-DV5000.
  - When the MPEG REC item is set to "SPLIT", only the VTR trigger button on the side panel is effective.
  - A red [e] mark appears on the GY-DV5000 LCD screen and recording/sending to the PC starts.
- Press the VTR triggerbutton of GY-DV5000 while the red [e] mark is displayed.
  - The [e] mark on the LCD screen of GY-DV5000 turns white and recording/sending to the PC stops.

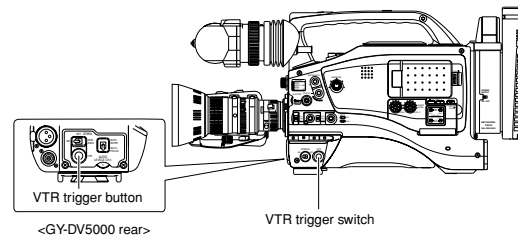

→ OVER

**About the Cast function (CAST)**

The Cast function can be used to send video/audio from KA-DV5000 to another PC.

**<Sending method>**

Display the video to send in the video display window of the Streamcapture screen and click the CAST-CAM button.



CAST-CAM button  
CAST-BARS button  
CAST-TRIG button

**<Color bar transmission>**

When clicking the BARS button, color bars are transmitted rather than the video from KA-DV5000.

- Video of the receiving side will be displayed with color bars. (Video from KA-DV5000 will be displayed in the video display of the Streamcapture screen. Color bars will not be displayed.)
- Click the CAST button to switch back to the transmission of video from KA-DV5000.
- To stop the transmission of video from KA-DV5000 / color bars, turn off the CAST-CAM/CAST-BARS button. In this case, the connection with the receiving side will be disconnected.

**<Trigger transmission>**

When transmitting video/audio from KA-DV5000 to another PC by synchronizing to the button operations of GY-DV5000, click the CAST-TRIG. Button. (≡ page 37)

**<Receiving sent video>**

Video sent using the Cast function can be received using Windows Media Player.

1. Launch Windows Media Player and select [Open URL] from the [File] menu.

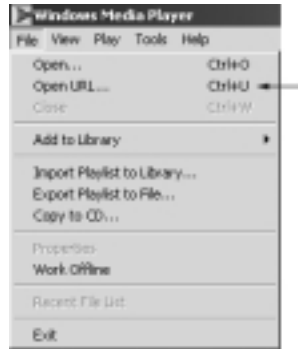

2. Input the IP address and port number of the PC sending data using Streamcapture.

\* The settings can be checked in "Internet URL" of the Cast dialog box.

- Internet connection



- LAN connection

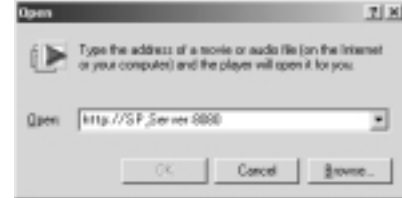

3. Click OK to view the received video.

**Caution**

When Windows Media Player is receiving a video being sent, sometimes the connection with a server can be cut off. In such a case, press the PLAY button of Windows Media Player again.

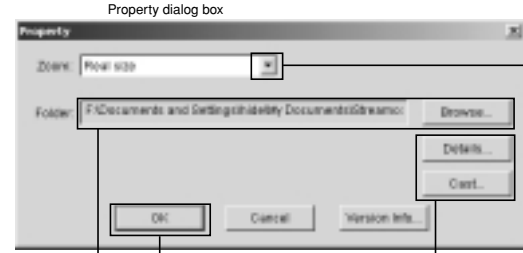

**Select the video display size**  
Select the display size from the pull-down menu.  
Setting range:  
• Real size  
• Fit to window

Click the OK button to confirm settings.

**Save destination folder**  
The default save destination is as follows:  
Set this field when changing the save destination folder.  
My Document\Streamcorder (YIPAddress)  
When changing the destination folder, press the Browse... button and select the desired folder.  
The changed destination folder will be the default folder for future save operations.

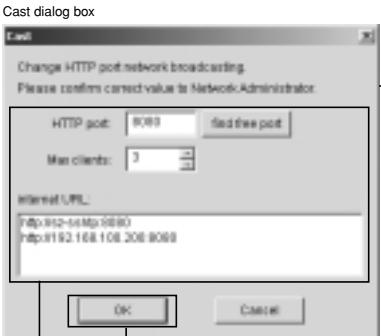

Click the OK button to confirm settings.

**HTTP port**  
Port number of the network used when sending video/audio is set. Normally, no user setting is required.  
**Max clients**  
Sent video/audio can be received up to the number specified in this dialog box.  
**Internet URL**  
When receiving video/audio, the URL displayed here is entered in Windows Media Player.

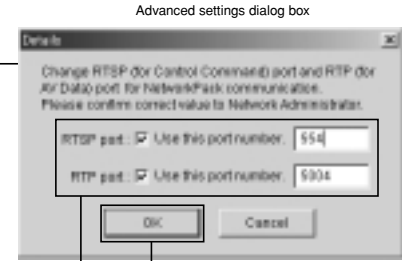

Click the OK button to confirm settings.

Port numbers of the network used on the PC side during communication with the network pack are set.  
RTSP port: used for handling commands. Use [TCP].  
RTP port: used for receiving video data. Use [UDP].  
Normally, available ports are automatically searched and set.  
If there are restrictions to the port numbers due to the LAN environment settings of your PC, consult your network administrator.  
When specifying the port numbers for use, check each checkbox and input the number in the edit box on the right.

## Others

## Troubleshooting

When there is a system error, network error, unit malfunction, etc., KA-DV5000 displays the error on the GY-DV5000 LCD screen or viewfinder screen.

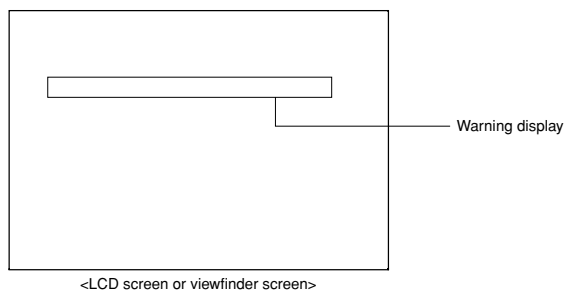

Screen display	Cause	Remedy	Reference page
<File system related>			
CF REMAIN 60SEC! (Flashing for 3 sec.)	Remaining time became less than 60 seconds during recording to CF memory card.	Stop recording and replace with a new CF memory card, or delete files on the current CF memory card to secure recording space.	25
CF REMAIN 30SEC!	Remaining time became less than 30 seconds during recording to CF memory card.		
CF REMAIN 20SEC!	Remaining time became less than 20 seconds during recording to CF memory card.		
CF REMAIN 10SEC!	Remaining time became less than 10 seconds during recording to CF memory card.		
CF FULL! (Displayed until CF recording stops)	Remaining time has run out during recording to CF memory card.		
CF FULL! (Flashing for 3 sec.)	Recording is being attempted on CF memory card with remaining time of less than 10 seconds.		
FORMAT ERROR!	Failed to format CF memory card.	Check the CF memory card and format again. If the card still cannot be formatted, contact your nearest JVC-authorized service agent.	17
NO CF FORMAT! (Flashing)	CF memory card is unformatted, or an unknown format is being used.	Check the CF memory card and format.	17

→ OVER

## Others

## Troubleshooting

Screen display	Cause	Remedy	Reference page
<Operation related>			
NO CF CARD! (Flashing for 3 sec.)	There is no CF memory card inserted.	Insert a CF memory card.	3
PROTECT! (Flashing for 3 sec.)	Deletion of a protected clip file was attempted.	To delete the clip file, remove the protection.	24
NO CLIP! (Flashing for 3 sec.)	There is no CF memory card inserted, of there is no clip file available.	Check the CF memory card.	—
SET WLAN AD HOC MODE OFF! (Flashing for 3 sec.)	Use of DHCP server was attempted while in the AD HOC mode.	Set DHCP in the NETWORK SET menu screen to OFF when using the AD HOC mode.	11
SET DHCP OFF! (Flashing for 3 sec.)	Selection of AD HOC mode was attempted while using DHCP server.	Set WLAN AD MOC MODE in the NETWORK SET menu screen to OFF when using DHCP server.	11



By using the PING command standard to Windows, it is possible to check whether the connection is correct and that communication can be made from the PC to KA-DV5000.

1. Launch the command prompt.
  - For Windows 2000  
From the Start button, select [Programs] → [Accessories] → [Command Prompt].
2. Input the following and press the Enter key.  
PING xxx.xxx.xxx.xxx  
(xxx.xxx.xxx.xxx is the IP address of the other party)  
Input example: When the IP address of the other party is "192.168.0.10"  
PING 192.168.0.010
3. Check to see that the other party is successfully displayed.  
If connection is not successful, "Request timed out" or "Destination host unreachable" message will appear.

- **IP address**  
Identification number assigned to each computer that is connected to a network. The address is used for communication between network devices.
- **LAN (Local Area Network)**  
A network structured within a relatively small range such as in a single building or an office of a company.
- **DHCP (Dynamic Host Control Protocol)**  
Method of automatically assigning IP address within a network. When a computer is connected to a network, the DHCP server automatically assigns the IP address.
- **WAN (Wide Area Network)**  
A network structured within a wide area such as between the main office of a company and its branch offices. Internet is also generally referred to as WAN.
- **Netmask**  
An IP address has the following two roles: 1) address for identifying the network, and 2) address for identifying individual computers. Netmask is a 32-bit value that defines the number of bits of the IP address to use for identifying the network.
- **Gateway**  
Hardware and software that translates different types of protocols when a computer communicates with another computer outside the network. The gateway IP address is referred to as the gateway address.
- **RTP (Realtime Transport Protocol)**  
Protocol to transmit in realtime digitalized video/audio data via a network.
- **RTSP (Real Time Streaming Protocol)**  
Protocol to control realtime transmission of video/audio data via a network.
- **HTTP (Hypertext Transport Protocol)**  
Protocol used when transferring HTML (Hypertext Markup Language) files between WWW server and browser.
- **Protocol**  
A set rule for a computer or communication device to perform communication over a network, etc.
- **IEEE802,11b**  
International standard for wireless LAN with maximum communication speed of 11Mbps.
- **Channel (wireless LAN)**  
Frequency range used by wireless LAN. The same frequency must be set by two sides for proper communication.  
If there is an access point, adapter, etc., using the same band in the proximity, there may be a hindrance in the communication and may reduce throughput or the quality of communication. When setting, check the settings of surrounding access points, etc., to avoid doubling.
- **ESS-ID (wireless LAN)**  
Network identification name used by wireless LAN. The name is used to distinguish other wireless LAN devices.
- **Ad hoc mode (wireless LAN)**  
A mode for direct communication without passing through an access point.
- **Infrastrucure (wireless LAN)**  
Form of communication via an access point.

## Others

## Terminology

### ● Encryption mode

Setting for encrypting the flow of data during wireless communication.

Following settings are available:

None (Open System): No encryption. Setting will be unavailable and throughput will be improved. However, there is the risk of information leakage.

40bit WEP: Encryption is performed using 40-bit encryption key.

128bit: Encryption is performed using 104-bit + 24-bit (1V) keys. Although throughput will decline compared to Open System, security of data will be improved.

### ● Access point (wireless LAN)

Relay point for infrastructure communication. It can also serve as the relay point for cable LAN or wireless LAN.

### ● ASF (Advanced Streaming Format)

Data streaming format developed by Microsoft Corporation (U.S.) for transmission of video and audio.

### ● Host name

Name of a device (not limited to a computer but all connection devices with an IP address) on a network.

### ● Port number

Number used for detecting applications and service during TCP/IP communication.

### ● TCP/IP

Abbreviation for Transmission Control Protocol/Internet Protocol and is one of the protocols used during network connection.

### ● UDP

Different from TCP, UDP is a low-level protocol that does not perform receive checks. In some cases, missing and distorted images may occur due to packet loss.

## Others

## Terminology

### ■ About IP address

#### Global IP address and local IP address

There are 2 types of IP addresses: "global IP address" and "local IP address".

**Global IP address:** Just as different IP addresses are needed on a network, all PCs using the Internet worldwide must use a unique IP address. This IP address is referred to as "global IP address". Normally, the global address is assigned by the IS provider.

**Local IP address:** In an environment not connected to the Internet (within a household, within a company, etc.), separate IP addresses can be used freely within a network. This IP address is referred to as "local IP address".

#### IP address classes

IP addresses are categorized into 3 classes depending on the number of PCs structuring a network.

"Class A IP addresses" are used for large-scale networks, "Class B IP addresses" are used for medium-scale networks and "Class C IP addresses" are used for small-scale networks.

Within a network, all IP addresses must be of the same class. Each IP address is structured by a series of 4 digit numbers separated by a period. The first number of the IP address indicates the class.



First number of the IP address	Class	Application (number of PCs structuring the network)
1~127	Class A	For large-scale networks (max. approx. 16 million units)
128~191	Class B	For medium-scale networks (max. approx. 65,000 units)
192~223	Class C	For small-scale networks (max. approx. 120 units)

\* "224 ~ 255" are normally not used for IP addresses.

For example, a network structured by a few PCs to dozens of PCs would use Class C IP addresses.

Normally, the following special IP addresses are used when structuring a network.

Class	Set IP address
Class A	10.0.0.0 ~ 10.255.255.255
Class B	172.16.0.0 ~ 172.31.255.255
Class C	192.168.0.0 ~ 192.168.255.255

#### About proxy server

A proxy is a "relay point" for accessing the Internet. When enabling "Use a proxy server", the proxy server will make access to the Internet.

Since various access information is cached at this time, downloading will be faster when reloading the same information from the Internet since the data is loaded from the proxy server.